



LIGITEK

LIGITEK ELECTRONICS CO.,LTD.
Property of Ligitek Only

FOUR DIGIT LED DISPLAY (0.28 Inch)

LFD265/64-XX

DATA SHEET

DOC. NO : QW0905-LFD265/64-XX

REV. : B

DATE : 13- Jul. - 2006



LIGITEK

LIGITEK ELECTRONICS CO.,LTD.
Property of Ligitek Only

PART NO. LFD265/64-XX

Page 1/7

Package Dimensions

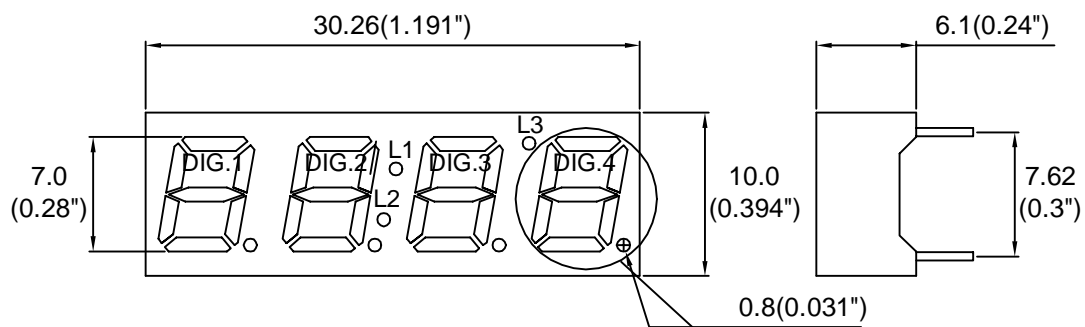

LFD265/64-XX
LIGITEK

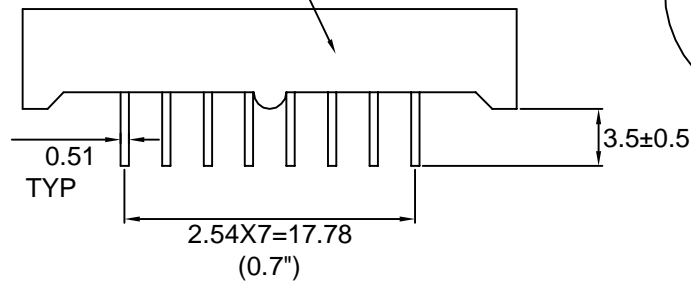

PIN NO.1 →

Note : 1.All dimension are in millimeters and (Inch) tolerance is ±0.25mm unless otherwise noted.
2.Specifications are subject to change without notice.



Internal Circuit Diagram

LFD2654-XX

LFD2664-XX

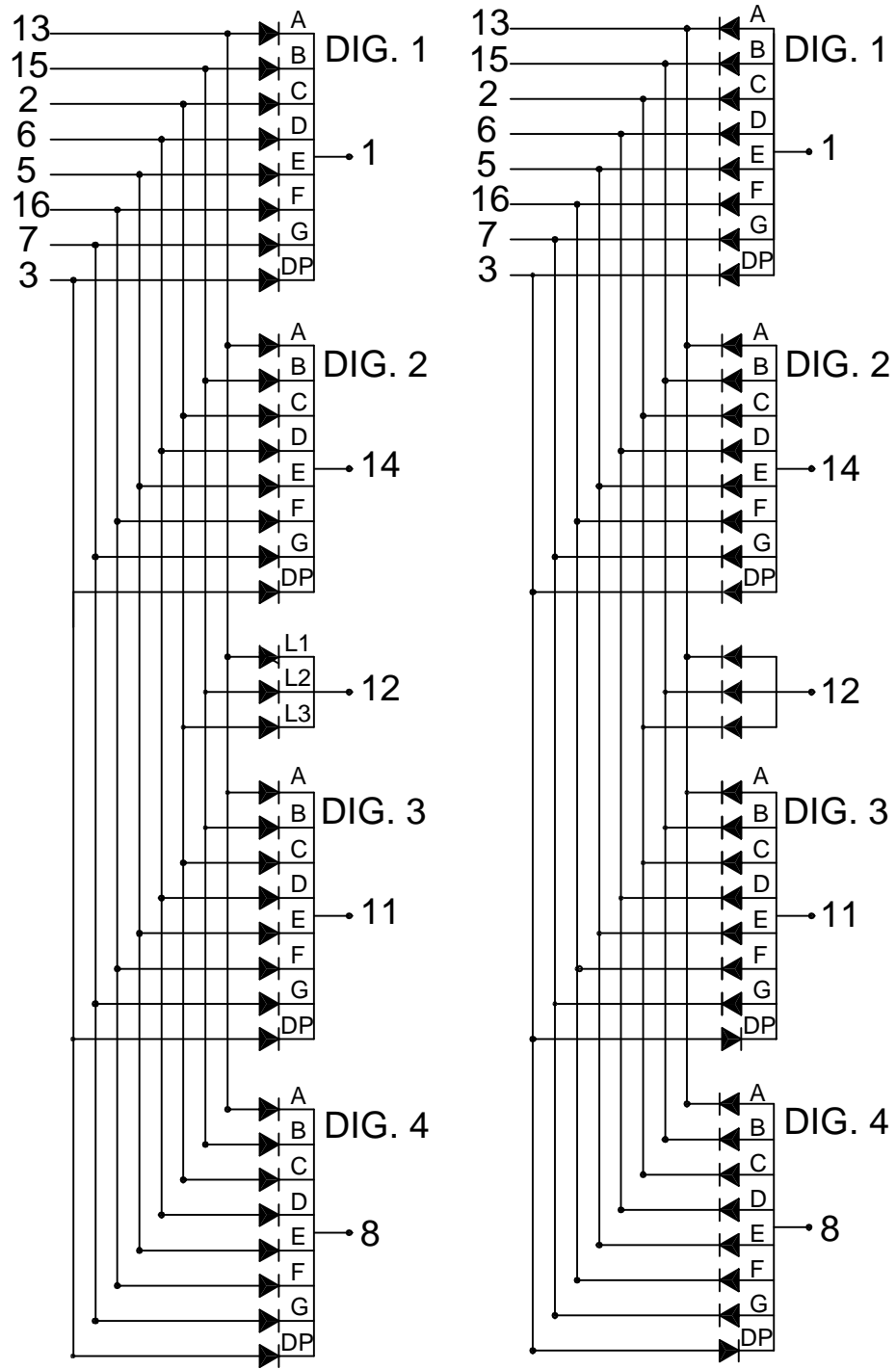

**Electrical Connection**

PIN NO.1	LFD2654-XX	PIN NO.1	LFD2664-XX
1	Common Cathode Dig.1	1	Common Anode Dig.1
2	Anode C,L3	2	Cathode C,L3
3	Anode DP	3	Cathode DP
4	NC	4	NC
5	Anode E	5	Cathode E
6	Anode D	6	Cathode D
7	Anode G	7	Cathode G
8	Common Cathode Dig.4	8	Common Anode Dig.4
9	NC	9	NC
10	NC	10	NC
11	Common Cathode Dig.3	11	Common Anode Dig.3
12	Common Cathode L1,L2,L3	12	Common Anode L1,L2,L3
13	Anode A ,L1	13	Cathode A,L1
14	Common Cathode Dig.2	14	Common Anode Dig.2
15	Anode B,L2	15	Cathode B,L2
16	Anode F	16	Cathode F



Absolute Maximum Ratings at Ta=25

Parameter	Symbol	Ratings	UNIT
		E	
Forward Current Per Chip	IF	30	mA
Peak Forward Current Per Chip (Duty 1/10,0.1ms Pulse Width)	IFP	120	mA
Power Dissipation Per Chip	PD	100	mW
Reverse Current Per Any Chip	Ir	10	μA
Operating Temperature	Topr	-25 ~ +85	
Storage Temperature	Tstg	-25 ~ +85	
Solder Temperature 1/16 Inch Below Seating Plane For 3 Seconds At 260			

Part Selection And Application Information(Ratings at 25)

PART NO	CHIP		common cathode or anode	P (nm)	(nm)	Electrical					IV-M
	Material	Emitted				Vf(v)			Iv(mcd)		
						Min.	Typ.	Max.	Min.	Typ.	
LFD2654-XX	GaAsP/GaP	Orange	Common Cathode	635	45	1.7	2.1	2.6	1.35	2.35	2:1
LFD2664-XX			Common Anode								

Note : 1.The forward voltage data did not including ±0.1V testing tolerance.
2. The luminous intensity data did not including ±15% testing tolerance.



Test Condition For Each Parameter

Parameter	Symbol	Unit	Test Condition
Forward Voltage Per Chip	Vf	volt	If=20mA
Luminous Intensity Per Chip	Iv	mcd	If=10mA
Peak Wavelength	P	nm	If=20mA
Spectral Line Half-Width		nm	If=20mA
Reverse Current Any Chip	Ir	μ A	Vr=5V
Luminous Intensity Matching Ratio	IV-M		



Typical Electro-Optical Characteristics Curve

E CHIP

Fig.1 Forward current vs. Forward Voltage

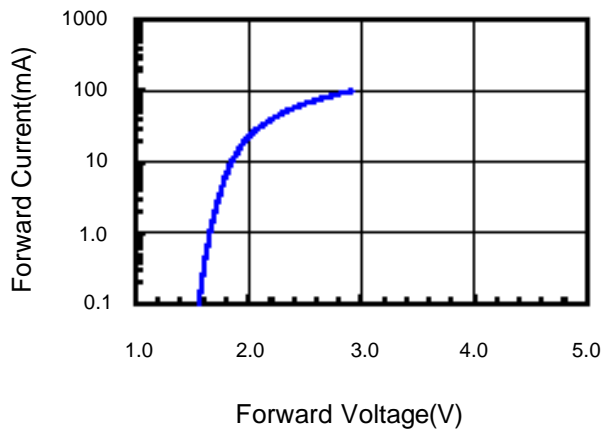

Fig.2 Relative Intensity vs. Forward Current

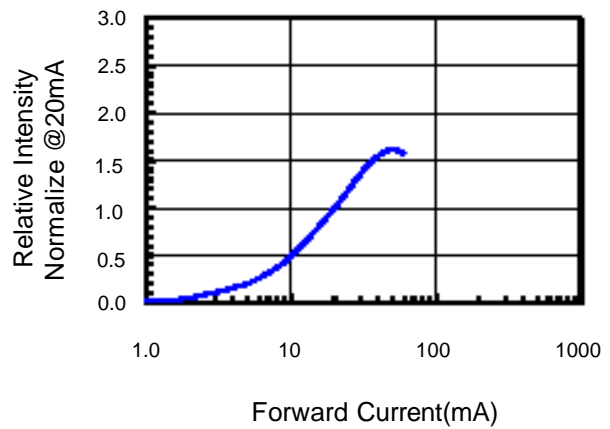

Fig.3 Forward Voltage vs. Temperature

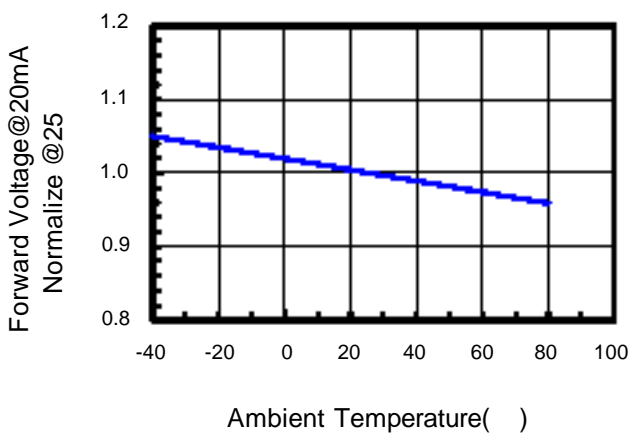

Fig.4 Relative Intensity vs. Temperature

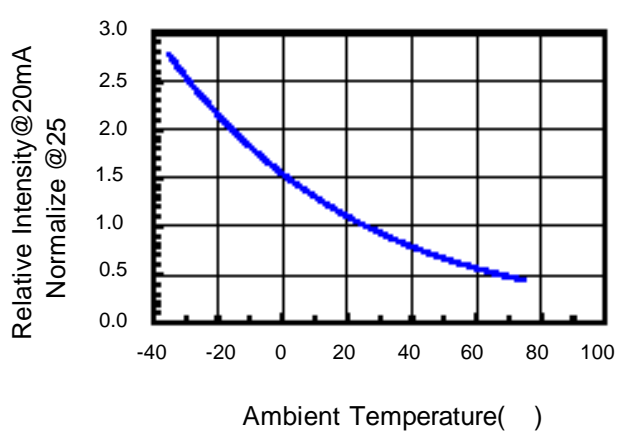
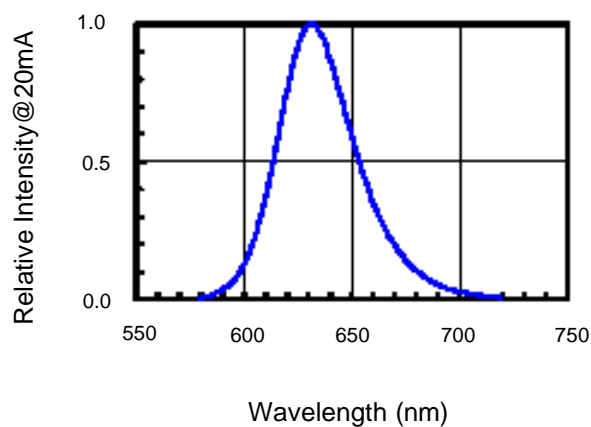

Fig.5 Relative Intensity vs. Wavelength





Reliability Test:

Test Item	Test Condition	Description	Reference Standard
Operating Life Test	1.Under Room Temperature 2.If=10mA 3.t=1000 hrs (-24hrs, +72hrs)	This test is conducted for the purpose of detemining the resisance of a part in electrical and themal stressed.	MIL-STD-750: 1026 MIL-STD-883: 1005 JIS C 7021: B-1
High Temperature Storage Test	1.Ta=105 ±5 2.t=1000 hrs (-24hrs, +72hrs)	The purpose of this is the resistance of the device which is laid under ondition of high temperature for hours.	MIL-STD-883:1008 JIS C 7021: B-10
Low Temperature Storage Test	1.Ta=-40 ±5 2.t=1000 hrs (-24hrs, +72hrs)	The purpose of this is the resistance of the device which is laid under condition of low temperature for hours.	JIS C 7021: B-12
High Temperature High Humidity Test	1.Ta=65 ±5 2.RH=90%-95% 3.t=240hrs ±2hrs	The purpose of this test is the resistance of the device under tropical for hous.	MIL-STD-202:103B JIS C 7021: B-11
Thermal Shock Test	1.Ta=105 ±5 & -40 ±5 (10min) (10min) 2.total 10 cycles	The purpose of this is the resistance of the device to sudden extreme changes in high and low temperature.	MIL-STD-202: 107D MIL-STD-750: 1051 MIL-STD-883: 1011
Solder Resistance Test	1.T.Sol=260 ±5 2.Dwell time= 10 ±1sec.	This test intended to determine the thermal characteristic resistance of the device to sudden exposures at extreme changes in temperature when soldering the lead wire.	MIL-STD-202: 210A MIL-STD-750: 2031 JIS C 7021: A-1
Solderability Test	1.T.Sol=230 ±5 2.Dwell time=5 ±1sec	This test intended to see soldering well performed or not.	MIL-STD-202: 208D MIL-STD-750: 2026 MIL-STD-883: 2003 JIS C 7021: A-2