



LIGITEK ELECTRONICS CO.,LTD.  
Property of Ligitek Only

LED SMD



Lead-Free Parts

LG-110RGB-CT

DATA SHEET

DOC. NO : QW0905-LG-110RGB-CT

REV. : D

DATE : 06 - Sep. - 2013



**Features:**

1. Package in 8.0mm carrier tape on 7" diameter reel.
2. Compatible with automatic placement equipment.
3. Compatible with reflow solder process.

**Descriptions:**

1. The LG-110 SMD Taping is much smaller than lead frame type components, thus enable smaller board size, higher packing density, reduced storage space and finally smaller equipment to be obtained.
2. Besides, lightweight makes them ideal for miniature applications. etc.

**Applications:**

1. Automotive : backlighting in dashboard and switch.
2. Telecommunication : indicator and backlighting in telephone and fax.
3. Flat backlight for LCD, switch and symbol
4. General use.

**Device Selection Guide:**

PART NO	MATERIAL	COLOR	
		Emitted	Lens
LG-110RGB-CT	AlGaInP	Red	Water Clear
	InGaN	Green	
	InGaN	Blue	

## Package Dimensions

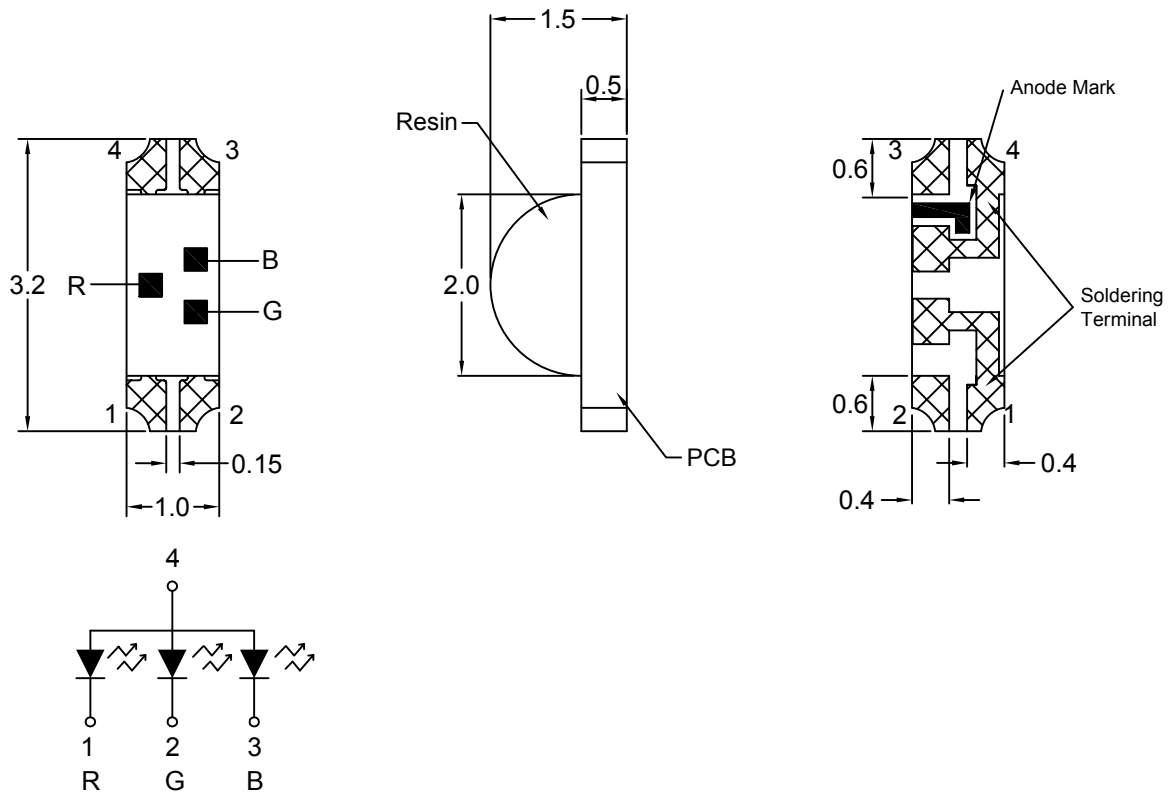

Note : 1.All dimension are in millimeter tolerance is  $\pm 0.1\text{mm}$  unless otherwise noted.  
2.Specifications are subject to change without notice.

## Recommended Soldering Pad Dimensions

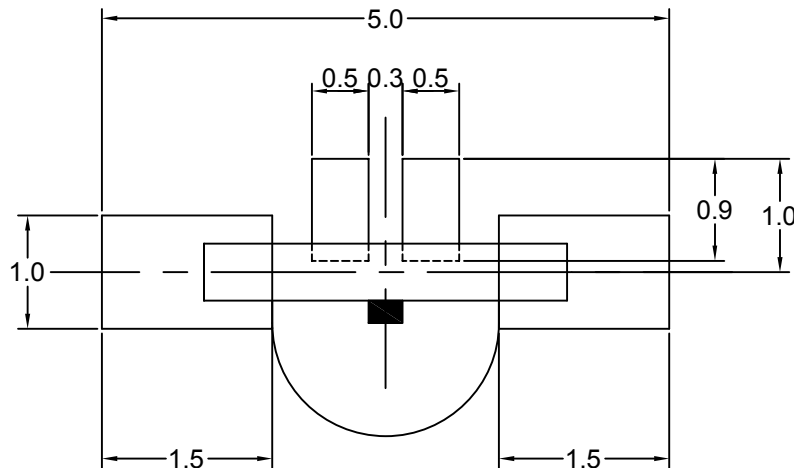

Note : The tolerances unless mentioned is  $\pm 0.1\text{mm}$ , Angle  $\pm 0.5$ . Unit=mm.

**Absolute Maximum Ratings at Ta=25 °C**

Parameter	Symbol	Ratings			UNIT
		URF	DGM	DBK	
Power Dissipation	PD	120	108	108	mW
Peak Forward Current Duty 1/10@10KHz	IFP	130	100	100	mA
Forward Current	IF	50	30	30	mA
Reverse Current @5V	Ir	10	50	50	μA
Electrostatic Discharge	ESD	2000	500		V
Operating Temperature	Topr	-20 ~ + 80			°C
Storage Temperature	Tstg	-30 ~ + 100			°C

Typical Electrical & Optical Characteristics (Ta=25 °C)

Items	Symbol	Min.	Typ.	Max.	UNIT	CONDITION	
Luminous Intensity	Iv	URF	80	150	----	mcd	IF=20mA
		DGM	320	550	----		
		DBK	80	150	----		
Dominant Wavelength	λD	URF	----	630	----	nm	IF=20mA
		DGM	----	525	----		
		DBK	----	470	----		
Spectral Line Half-Width	Δλ	URF	----	20	----	nm	IF=20mA
		DGM	----	36	----		
		DBK	----	30	----		
Forward Voltage	VF	URF	1.5	----	2.4	V	IF=20mA
		DGM	2.8	----	3.6		
		DBK	2.8	----	3.6		
Viewing Angle	2θ 1/2	URF	----	120	----	deg	IF=20mA
		DGM	----	120	----		
		DBK	----	120	----		

### Luminous Intensity Classification

BIN CODE		lv(mcd) at 20mA	
		Min.	Max.
URF	Q	80	125
	R	125	200

BIN CODE		lv(mcd) at 20mA	
		Min.	Max.
DGM	T	320	500
	U	500	800
	V	800	1250

BIN CODE		lv(mcd) at 20mA	
		Min.	Max.
DBK	Q	80	125
	R	125	200

## Typical Electro-Optical Characteristics Curve URF CHIP

Fig.1 Forward current vs. Forward Voltage

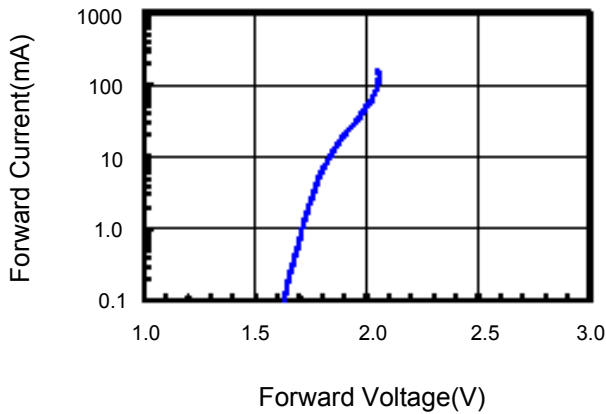

Fig.2 Relative Intensity vs. Forward Current

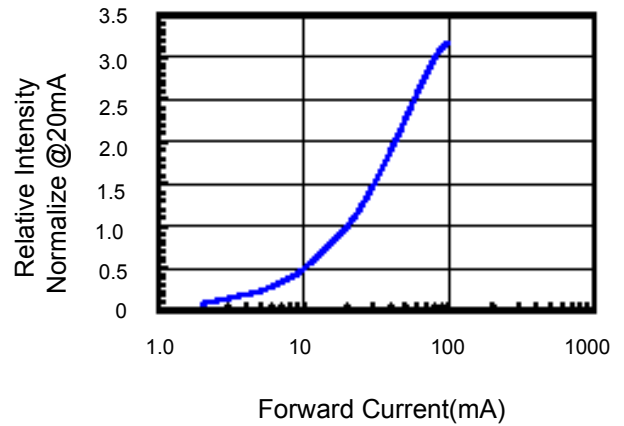

Fig.3 Forward Voltage vs. Temperature

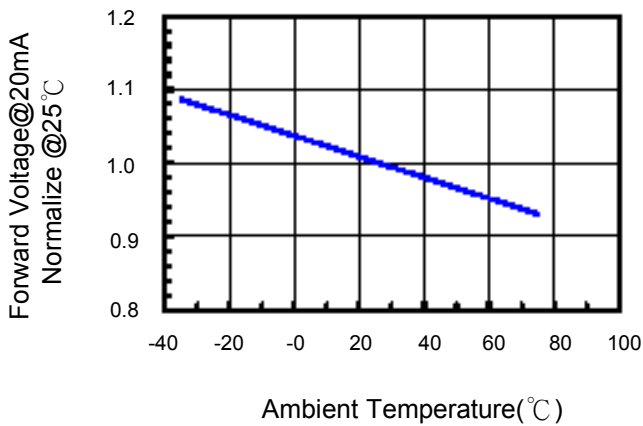

Fig.4 Relative Intensity vs. Temperature

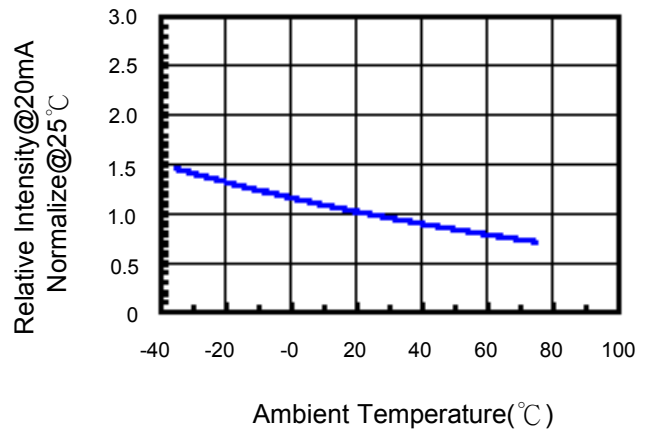

Fig.5 Relative Intensity vs. Wavelength

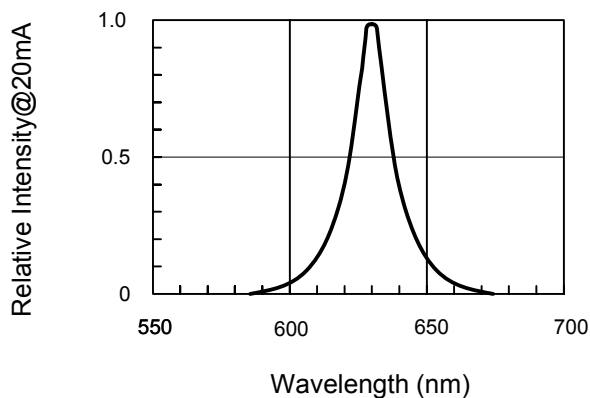
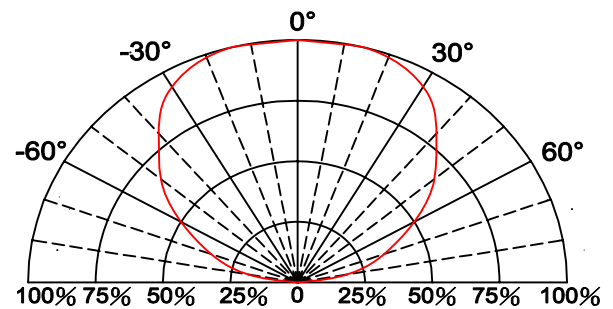

Fig.6 Directive Radiation



### Typical Electro-Optical Characteristics Curve

DGM CHIP

Fig.1 Forward current vs. Forward Voltage

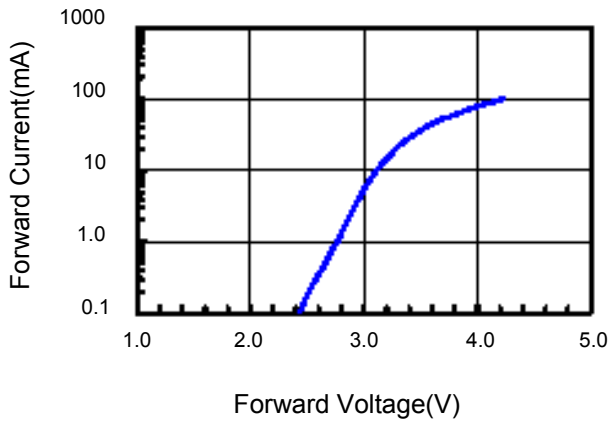

Fig.2 Relative Intensity vs. Forward Current

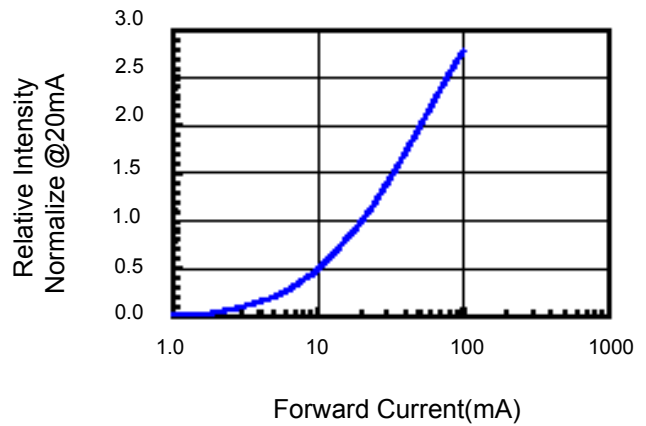

Fig.3 Forward Voltage vs. Temperature

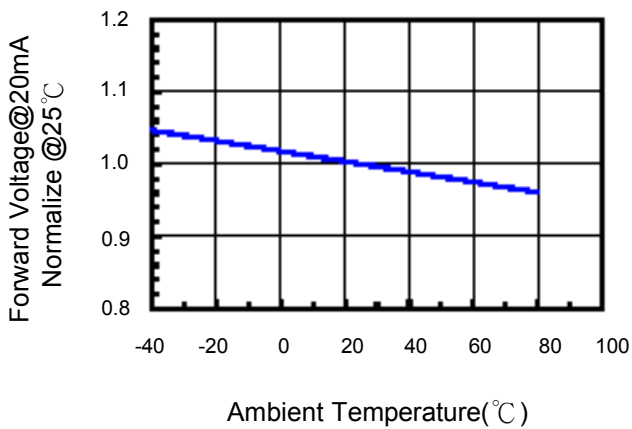

Fig.4 Relative Intensity vs. Temperature

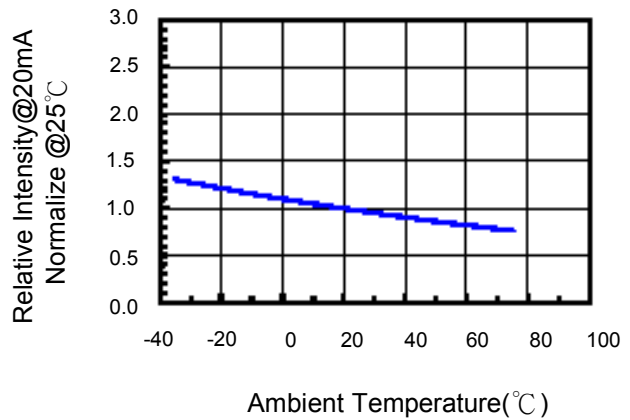

Fig.5 Relative Intensity vs. Wavelength

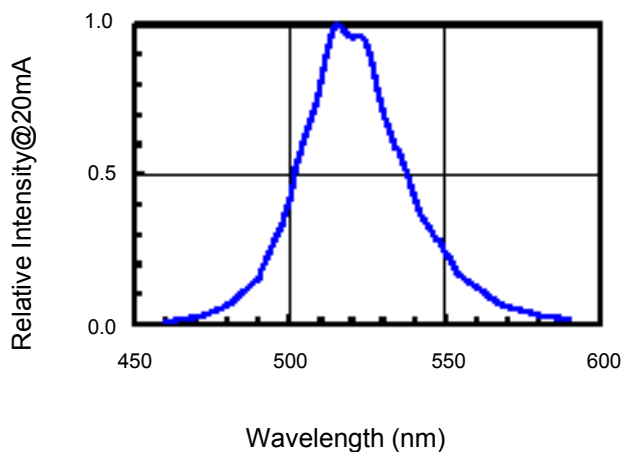
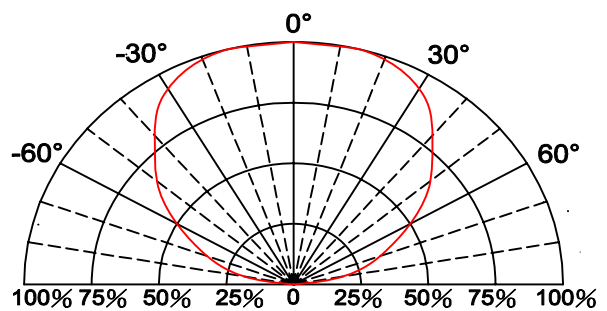

Fig.6 Directive Radiation





## Typical Electro-Optical Characteristics Curve

DBK CHIP

Fig.1 Forward current vs. Forward Voltage

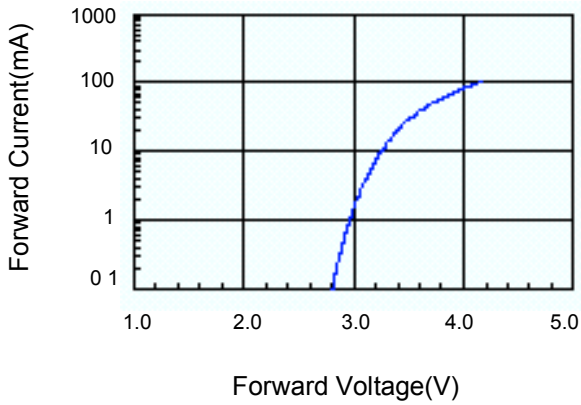

Fig.2 Relative Intensity vs. Forward Current

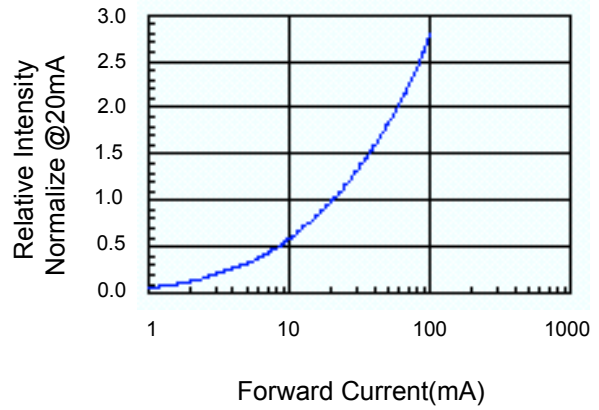

Fig.3 Forward Voltage vs. Temperature

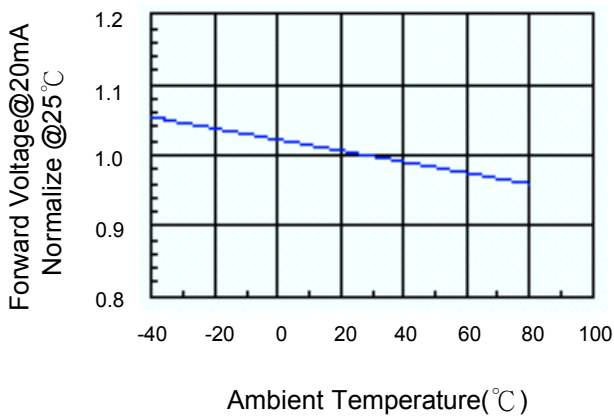

Fig.4 Relative Intensity vs. Temperature

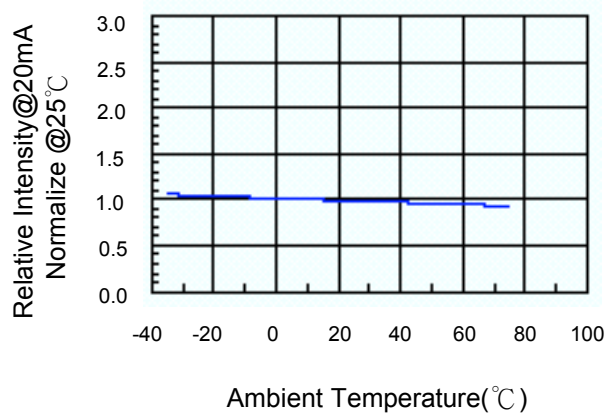

Fig.5 Relative Intensity vs. Wavelength

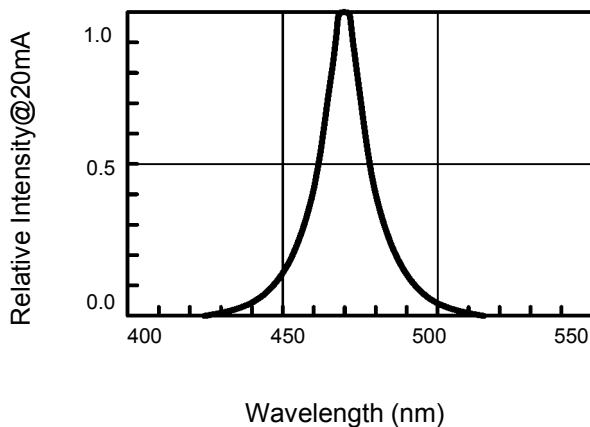
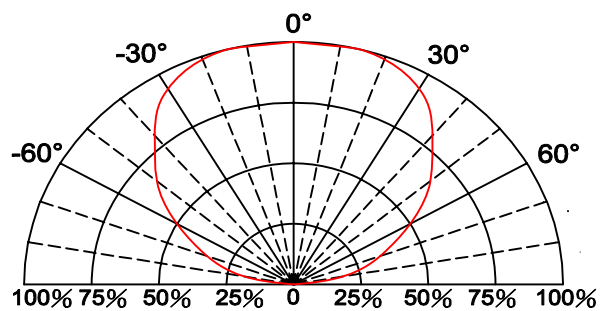
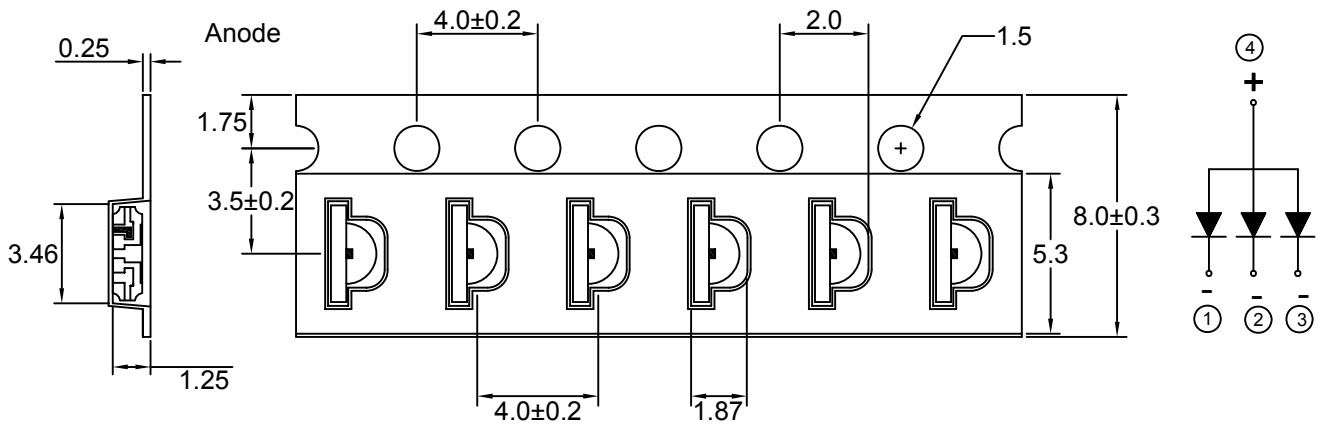

Fig.6 Directive Radiation



## Carrier Type Dimensions







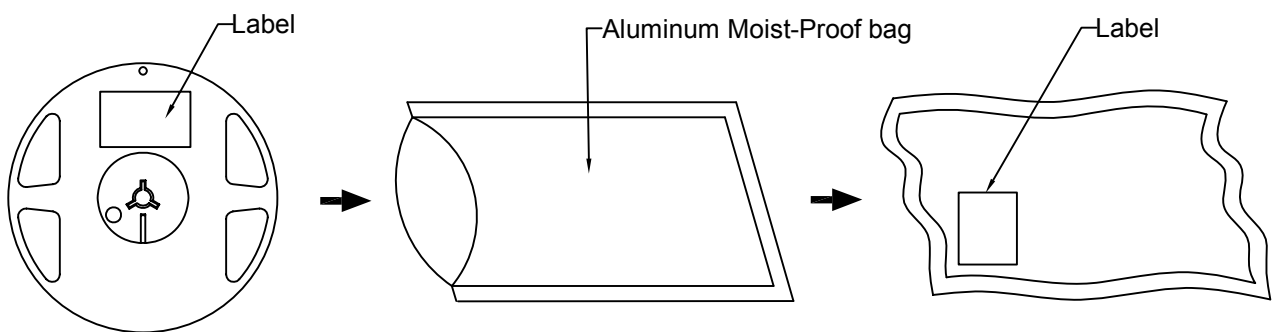

Note : The tolerances unless mentioned is  $\pm 0.1\text{mm}$ , Angle  $\pm 0.5$ . Unit=mm.

### • Packing Specifications



Part No.	Description	Quantity/Reel
LG-110RGB-CT	8.0mm tape,7"reel	3000 devices

## Label Explanation

	LIGITEK ELECTRONICS CO., LTD.	
		
	PART :	LG-110RGB-CT
		
	LOT :	GS11380168
		VF: 1.5-2.4
		VF: 2.8-3.6
QTY(PCS):	3000	
		VF: 2.8-3.6
BIN/HUE :	Q/T/Q	

BIN : Luminous Intensity

VF : Forward Voltage

## Reel Dimensions

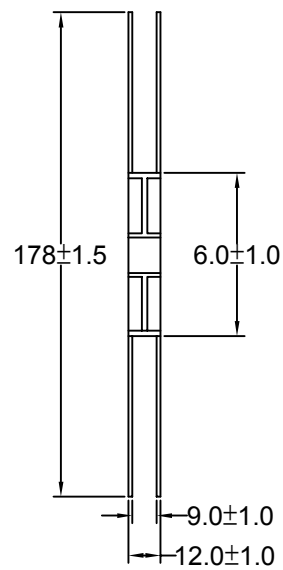
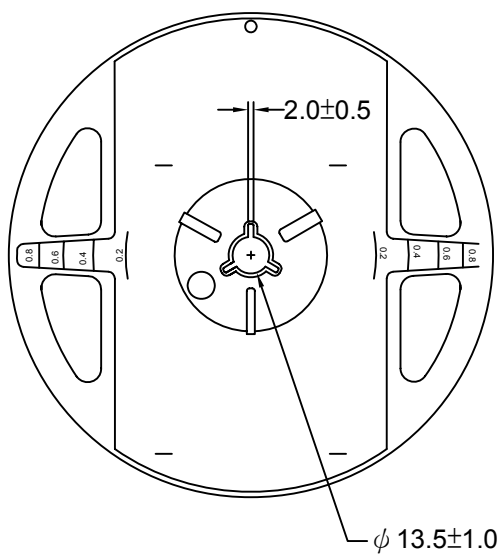

## Box Explanation

1. 5 BAG / INNER BOX
2. INNER BOX SIZE : L X W X H 23cm X 8.5cm x 26cm

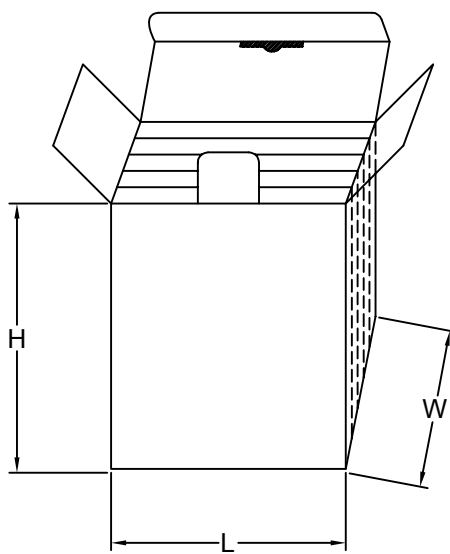

3. 10 INNER BOXES / CARTON
4. CARTON SIZE : L X W X H 58cm X 34cm x 35cm

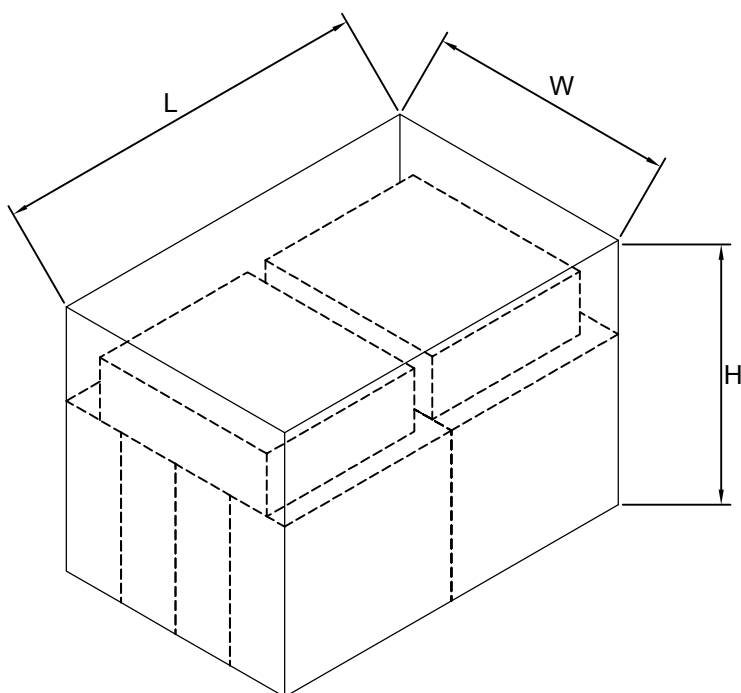

## Recommended Soldering Conditions

### 1. Hand Solder

Basic spec is  $\leq 280^{\circ}\text{C}$  3 sec one time only.

### 2. Wave Solder

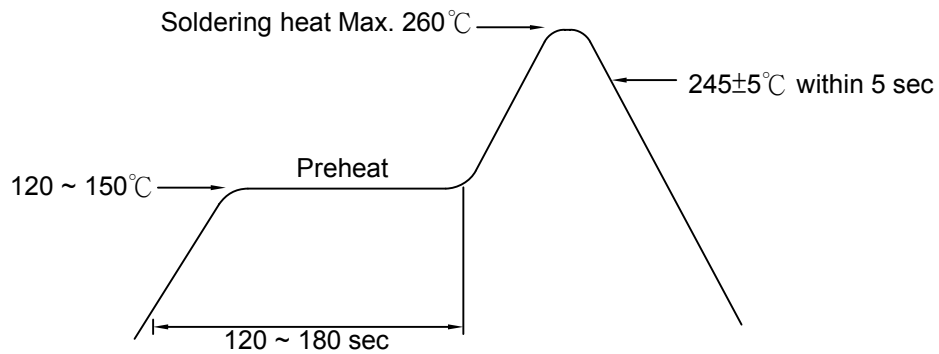

### 3. PB-Free Reflow Solder

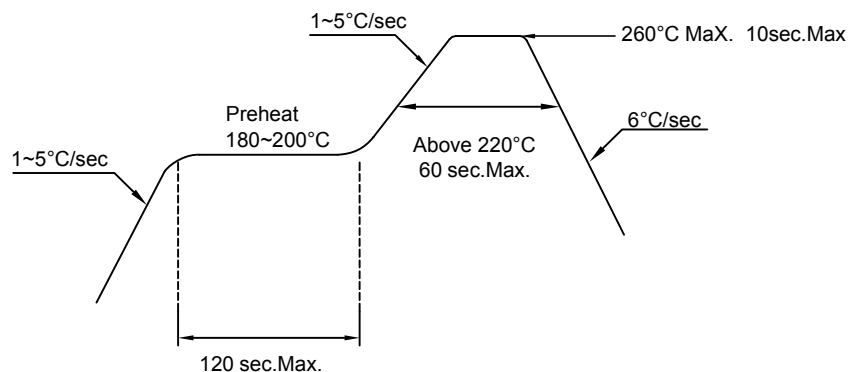

#### Note:

- 1.Reflow soldering should not be done more than two times.
- 2.When soldering,do not put stress on the LEDs during heating.
- 3.After soldering,do not warp the circuit board.

**Precautions For Use:****Storage time:**

- 1.The operation of Temperatures and RH are :  $5^{\circ}\text{C}\sim 35^{\circ}\text{C}$  ,RH60%.
- 2.Once the package is opened, the products should be used within a week.  
Otherwise, they should be kept in a damp proof box with desiccating agent.  
Considering the tape life, we suggest our customers to use our products within a year(from production date).
- 3.If opened more than one week in an atmosphere  $5^{\circ}\text{C} \sim 35^{\circ}\text{C}$  ,RH60%, they should be treated at  $60^{\circ}\text{C}\pm 5^{\circ}\text{C}$  for 15hrs.

**Drive Method:**

LED is a current operated device, and therefore, requires some kind of current limiting incorporated into the driver circuit. This current limiting typically takes the form of a current limiting resistor placed in series with the LED.

Consider worst case voltage variations that could occur across the current limiting resistor. The forward current should not be allowed to change by more than 40% of its desired value.

Circuit model A

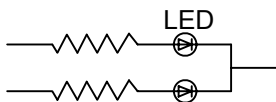

Circuit model B

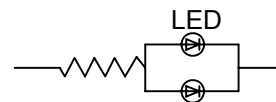

(A) Recommended circuit.

(B) The difference of brightness between LED could be found due to the VF-IF characteristics of LED.

**Cleaning:**

Use alcohol-based cleaning solvents such as isopropyl alcohol to clean the LED.

**ESD(Electrostatic Discharge):**

Static Electricity or power surge will damage the LED. Use of a conductive wrist band or anti-electrostatic glove is recommended when handling these LED. All devices, equipment and machinery must be properly grounded.

Reliability Test:

Classification	Test Item	Test Condition	Reference Standard
Endurance Test	Operating Life Test	1.Ta=Under Room Temperature As Per Data Sheet Maximum Rating. 2.If=20mA 3.t=1000 hrs (-24hrs, +72hrs)	MIL-STD-750D: 1026 MIL-STD-883D: 1005 JIS C 7021: B-1
	High Temperature Storage Test	1.Ta=105°C±5°C 2.t=1000 hrs (-24hrs, +72hrs)	MIL-STD-883D:1008 JIS C 7021: B-10
	Low Temperature Storage Test	1.Ta=-40°C±5°C 2.t=1000 hrs (-24hrs, +72hrs)	JIS C 7021: B-12
	High Temperature High Humidity Storage Test	1.Ta=65°C±5°C 2.RH=90%~95% 3.t=1000hrs jÖ2hrs	MIL-STD-202F:103B JIS C 7021: B-11
Environmental Test	Thermal Shock Test	1.Ta=105°C±5°C & -40°C±5°C (10min) (10min) 2.total 10 cycles	MIL-STD-202F: 107D MIL-STD-750D: 1051 MIL-STD-883D: 1011
	Solderability Test	1.T.Sol=235°C±5°C 2.Immersion time 2±0.5sec 3.Coverage ≥95% of the dipped surface	MIL-STD-202F: 208D MIL-STD-750D: 2026 MIL-STD-883D: 2003 IEC 68 Part 2-20 JIS C 7021: A-2
	Temperature Cycling	1.105°C ~ 25°C ~ -55°C ~ 25°C 30mins 5mins 30mins 5mins 2.10 Cyeles	MIL-STD-202F: 107D MIL-STD-750D: 1051 MIL-STD-883D: 1010 JIS C 7021: A-4
	IR Reflow	1.T=260°C Max. 10sec.Max. 2. 6 Min	MIL-STD-750D:2031.2 J-STD-020