



LIGITEK ELECTRONICS CO.,LTD.
Property of Ligitek Only

INFRARED EMITTING DIODES



Lead-Free Parts

LHIR3333-T50/A-PF

DATA SHEET

DOC. NO : QW0905-LHIR3333-T50/A-PF

REV. : A

DATE : 24 - Aug. - 2017



Package Dimensions

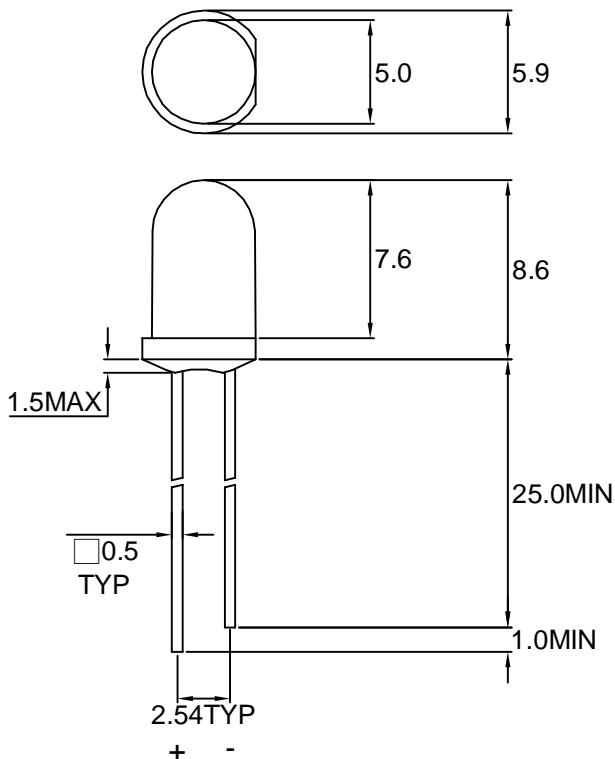

Note : 1.All dimension are in millimeter tolerance is $\pm 0.25\text{mm}$ unless otherwise noted.
2.Specifications are subject to change without notice.

Features:

1. High radiant intensity.
2. Suitable for pulsed applications.
3. Low average degradation.

Descriptions:

The LHIR3333-T50/A-PF series are high power solution grown efficiency Gallium Arsenide infrared emitting diodes encapsulated in water clear plastic T-1 3/4 package individually

Device Selection Guide:

PART NO	MATERIAL	LENS COLOR
LHIR3333-T50/A-PF	GaAIAs	Water Clear

Absolute Maximum Ratings at Ta=25°C

Parameter	Symbol	Ratings	UNIT
		HIR	
Forward Current	IF	50	mA
Peak Forward Current (300PPS, 10 μs Pulse)	IFP	1	A
Power Dissipation	PD	100	mW
Reverse Voltage	Vr	5	V
Electrostatic Discharge	ESD	2000	V
Operating Temperature	Topr	-40 ~ +85	°C
Storage Temperature	Tstg	-40 ~ +85	°C

Electrical Optical Characteristics (Aa=25°C)

PARAMETER	SYMBOL	Min.	Typ.	Max.	UNIT	TEST CONDITION
Radiant Intensity	Le	50	85		mW/sr	IF=50mA
Aperture Radiant Incidence	Ee	4	7		mW/cm ²	IF=50mA
Peak Emission Wavelength	λ peak		850		nm	IF=50mA
Spectral Line Half Width	Δλ		50		nm	IF=50mA
Forward Voltage	VF	1.2		1.6	V	IF=50mA
Reverse Current	IR			100	μA	VR=5V
Viewing Angle	2θ 1/2		20		deg	

Note : 1. The forward voltage data did not including ±0.1V testing tolerance.
2. The radiant intensity data did not including ±15% testing tolerance.

Brightness Code For Standard LED Lamps

Bin Code

HIR CHIP

Group	Radiant Intensity(mW/sr)at 50 mA	
	Min.	Max.
A16	50	60
A17	60	75
A18	75	85
A19	85	105
A20	105	125
A21	125	150
A22	150	180
A23	180	220

Typical Electro-Optical Characteristics Curve

HIR CHIP

Fig.1 Forward Current vs. Forward Voltage

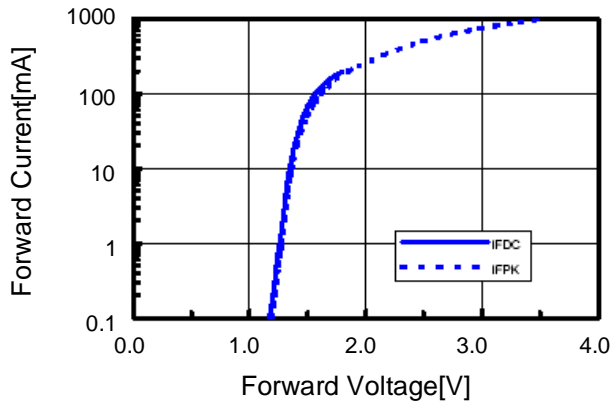

Fig.2 Relative Radiant Power vs. Wavelength

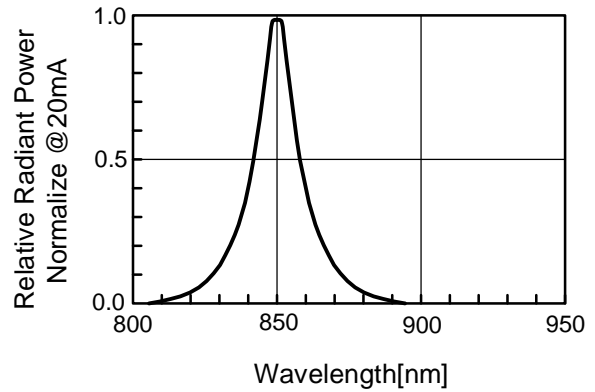

Fig.3 Relative Radiant Power vs. Forward DC Current

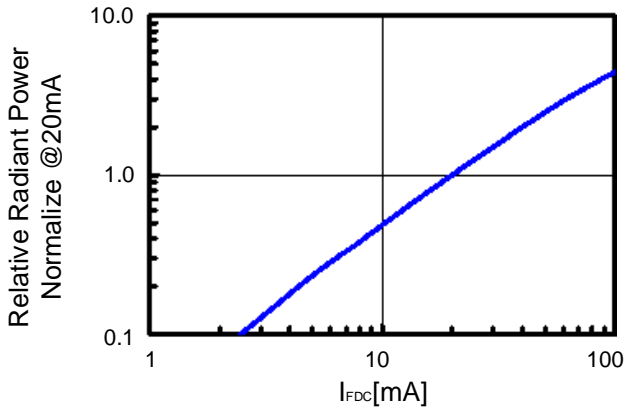

Fig.4 Relative Radiant Power vs. Forward Peak Current

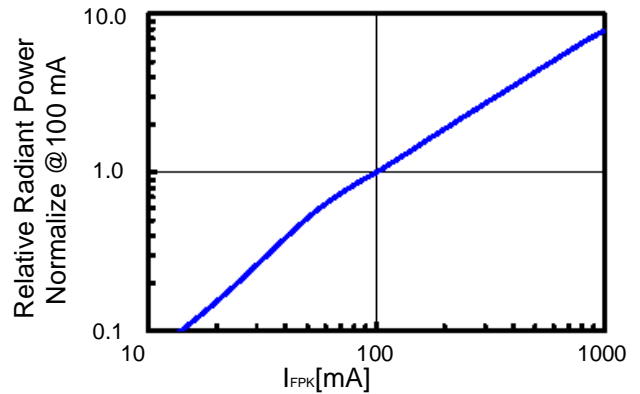

Fig.5 Forward DC Voltage vs. Temperature

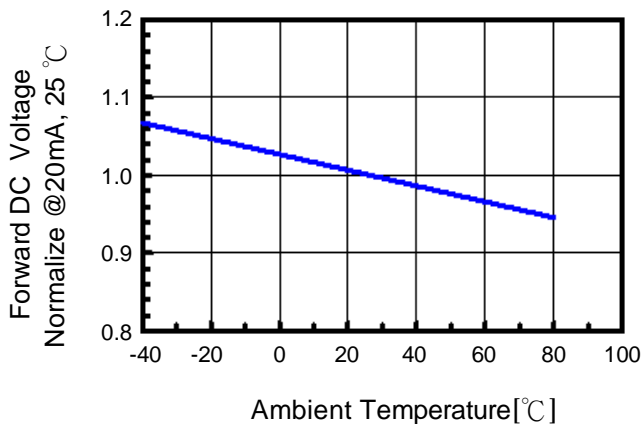
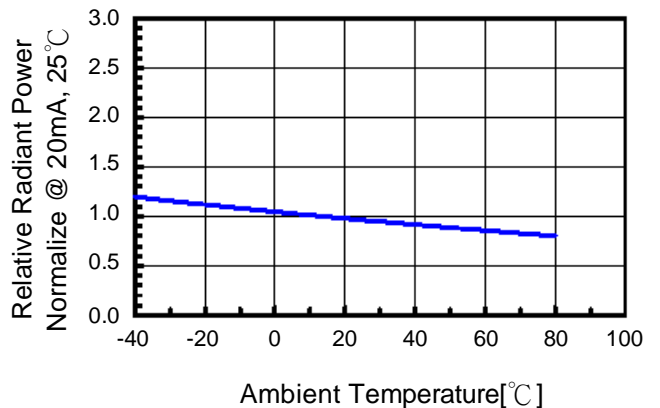

Fig.6 Relative Radiant Power vs. Temperature



Storage time:

- 1.The operation of Temperatures and RH are : $5^{\circ}\text{C} \sim 35^{\circ}\text{C}$,RH<60%.
- 2.Once the package is opened, the products should be used within a week.
Otherwise, they should be kept in a damp proof box with descanting agent.
Considering the tape life, we suggest our customers to use our products within a year(from production date).
- 3.If opened more than one week in an atmosphere $5^{\circ}\text{C} \sim 35^{\circ}\text{C}$,RH<60%, they should be treated at $60^{\circ}\text{C} \pm 5^{\circ}\text{C}$ for 15hrs.

Drive Method:

LED is a current operated device, and therefore, require some kind of current limiting incorporated into the driver circuit. This current limiting typically takes the form of a current limiting resistor placed in series with the LED.

Consider worst case voltage variations than could occur across the current limiting resistor. The forward current should not be allowed to change by more than 40% of its desired value.

Circuit model A

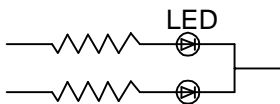

Circuit model B

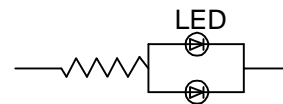

(A) Recommended circuit.

(B) The difference of brightness between LED could be found due to the VF-IF characteristics of LED.

Cleaning:

Use alcohol-based cleaning solvents such as isopropyl alcohol to clean the LED.

ESD(Electrostatic Discharge):

Static Electricity or power surge will damage the LED. Use of a conductive wrist band or anti-electrosatic glove is recommended when handing these LED. All devices, equipment and machinery must be properly grounded.

Mounting:

1. If the leads are subjected to stress during soldering a printed circuit board, illumination failure may result immediately or later during use. For this reason, make sure that the intervals between the installation holes in the board are equal to the intervals between the leads (after forming if done) so that no stress is applied to the lead.

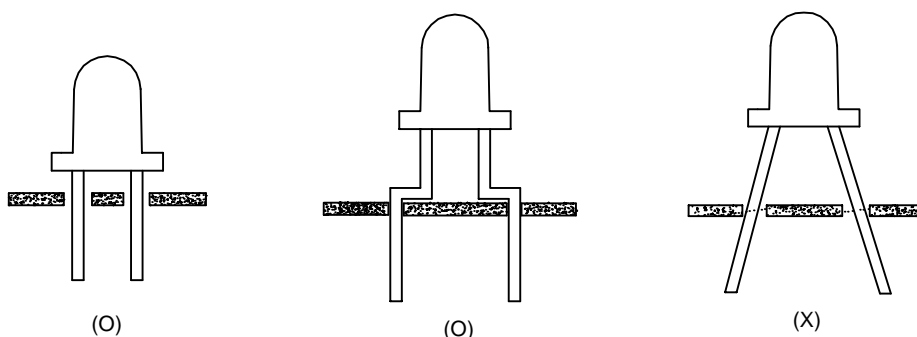

2. The LED lamps are designed for high-density mounting and have a structure which can alleviate mechanical stress due to clinching. Nevertheless, take care to avoid the occurrence of residual mechanical stress due to clinching.

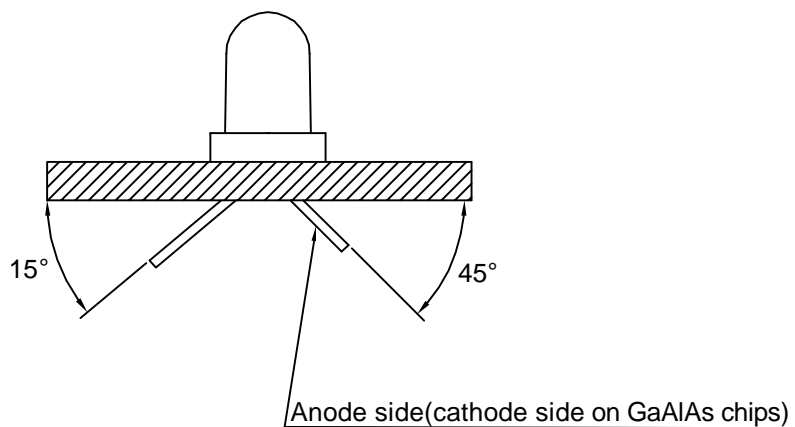

Soldering Condition(Pb-Free)

1.Iron:

Soldering Iron:30W Max
Temperature 350 ° C Max
Soldering Time:3 Seconds Max(One time only)
Distance:2mm Min(From solder joint to body)

2.Wave Soldering Profile

Dip Soldering
Preheat: 120 ° C Max
Preheat time: 60seconds Max
Ramp-up
2° C/sec(max)
Ramp-Down:-5 ° C/sec(max)
Solder Bath:260 ° C Max
Dipping Time:3 seconds Max
Distance:2mm Min(From solder joint to body)

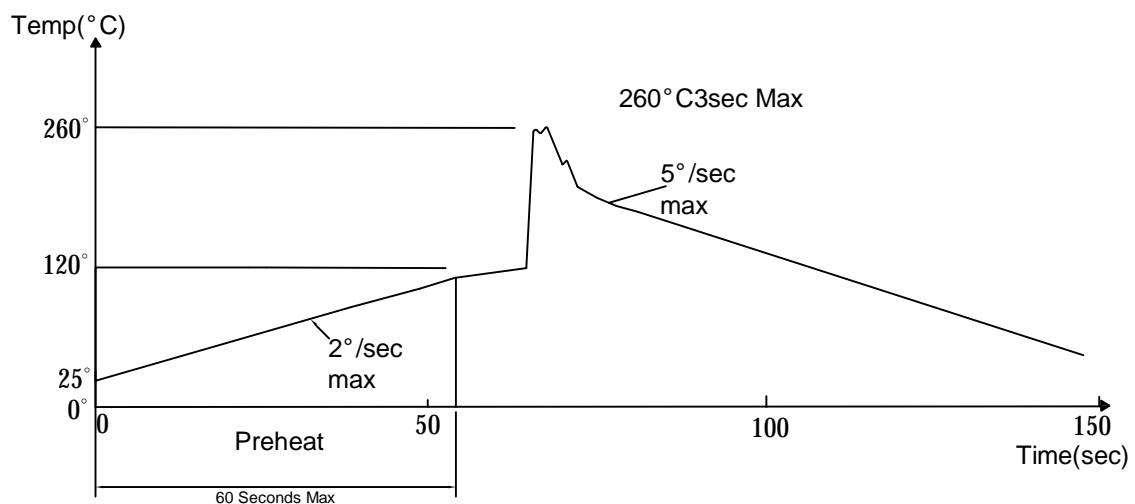

Note: 1.Wave solder should not be made more than one time.
2.You can just only select one of the soldering conditions as above.

Reliability Test:

Test Item	Test Condition	Description	Reference Standard
Operating Life Test	1.Under Room Temperature 2.If=20mA 3.t=1000 hrs (-24hrs, +72hrs)	This test is conducted for the purpose of detemining the resistance of a part in electrical and themal stressed.	MIL-STD-750: 1026 MIL-STD-883: 1005 JIS C 7021: B-1
High Temperature Storage Test	1.Ta=85°C±5°C 2.t=1000 hrs (-24hrs, +72hrs)	The purpose of this is the resistance of the device which is laid under condition of high temperature for hours.	MIL-STD-883:1008 JIS C 7021: B-10
Low Temperature Storage Test	1.Ta=-40°C±5°C 2.t=1000 hrs (-24hrs, +72hrs)	The purpose of this is the resistance of the device which is laid under condition of low temperature for hours.	JIS C 7021: B-12
High Temperature High Humidity Test	1.Ta=65°C±5°C 2.RH=90%~95% 3.t=240hrs±2hrs	The purpose of this test is the resistance of the device under tropical for hours.	MIL-STD-202:103B JIS C 7021: B-11
Thermal Shock Test	1.Ta=105°C±5°C & -40°C±5°C (10min) (10min) 2.total 10 cycles	The purpose of this is the resistance of the device to sudden extreme changes in high and low temperature.	MIL-STD-202: 107D MIL-STD-750: 1051 MIL-STD-883: 1011
Solder Resistance Test	1.T.Sol=260°C±5°C 2.Dwell time= 10±1sec.	This test intended to determine the thermal characteristic resistance of the device to sudden exposures at extreme changes in temperature when soldering the lead wire.	MIL-STD-202: 210A MIL-STD-750: 2031 JIS C 7021: A-1
Solderability Test	1.T.Sol=245°C±5°C 2.Dwell time=5±1sec	This test intended to see soldering well performed or not.	MIL-STD-202: 208D MIL-STD-750: 2026 MIL-STD-883: 2003 JIS C 7021: A-2

PACKING SPECIFICATION

1.500 PCS / BAG

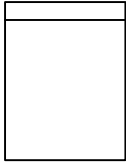

2. 10 BAG / INNER BOX

SIZE : L X W X H 33.5cm X 19cm X 7.5cm

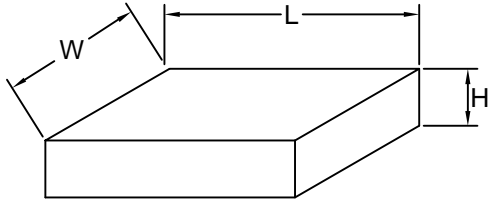

3. 12 INNER BOXES / CARTON

SIZE : L X W X H 58.5cm X 34cm X 34cm

