

INFRARED EMITTING DIODES



Lead-Free Parts

LSIR21931F/A-PF

DATA SHEET

DOC. NO : QW0905-LSIR21931F/A-PF

REV : A

DATE : 30- Aug. - 2017



Package Dimensions

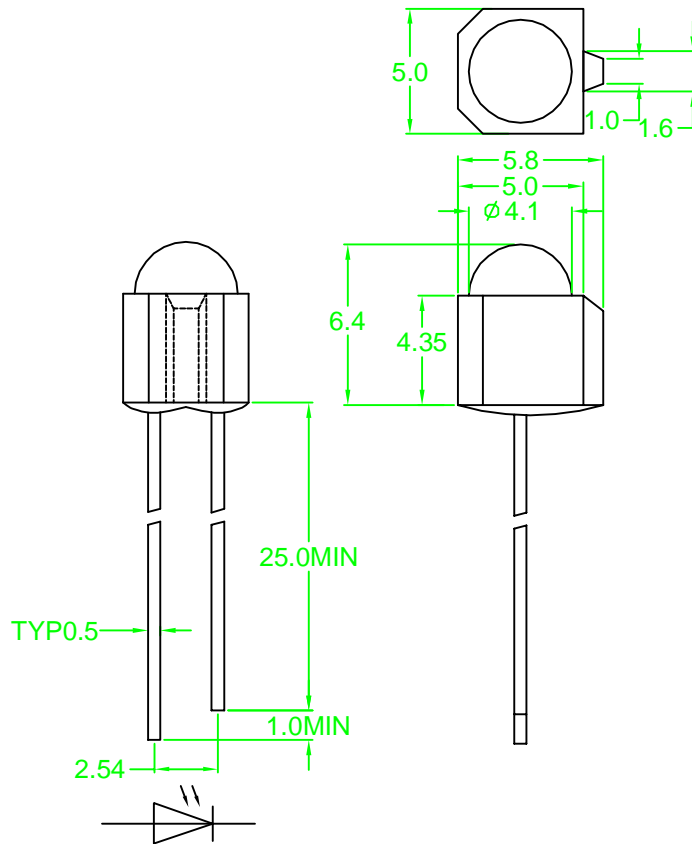

Note : 1.All dimension are in millimeter tolerance is ± 0.25 mm unless otherwise noted.
2.Specifications are subject to change without notice.

Features:

1. High radiant intensity.
2. Suitable for pulse applications.
3. Low average degradation.

Descriptions:

The LSIR21931F/A-PF series are super-high efficiency Gallium Aluminum Arsenide infrared emitting diodes encapsulated in water clear plastic T-1 3/4 package individually

Device Selection Guide:

PART NO	MATERIAL	LENS COLOR
LSIR21931F/A-PF	AlGaAs	Blue Transparent

Absolute Maximum Ratings at Ta=25 °C

Parameter	Symbol	Ratings	UNIT
		SIR(F)	
Forward Current	IF	50	mA
Peak Forward Current (200uS,every 4 seconds)	IFP	0.5	A
Peak Forward Current (300PPS,1 μ s Pulse)	IFP	3	A
Power Dissipation	PD	100	mW
Reverse Voltage	Vr	5	V
Electrostatic Discharge(*)	ESD	2000	V
Operating Temperature	Topr	-55 ~ +100	°C
Storage Temperature	Tstg	-55 ~ +100	°C
Storage Term	Shelf life of the products in unopened bag is 3 months(max) at <30° C and 70% RH from the delivery date.If the shelf life exceeds 3 months or more, the LEDs need to be stored in a sealed container with desiccant(silica gel) to ensure their shelf life will not exceed 1 year		

Electrical Optical Characteristics (Aa=25°C)

PARAMETER	SYMBOL	Min.	Typ.	Max.	UNIT	TEST CONDITION
Radiant Intensity	Le	14	24		mW/sr	IF=20mA
Aperture Radiant Incidence	Ee	2	3.4		mW/cm ²	IF=20mA
Peak Wavelength	λ peak		880		nm	IF=20mA
Spectral Line Half Width	Δ λ		40		nm	IF=20mA
Forward Voltage	VF		1.4	1.7	V	IF=20mA
Reverse Current	IR			100	μ A	VR=5V
Viewing Angle	2 θ 1/2		22		deg	

Note : 1.The forward voltage data did not including ±0.1V testing tolerance.
2. The radiant intensity data did not including ±15% testing tolerance.

Brightness Code For Standard LED Lamps

SIR(F) CHIP

Group	Luminous Intensity(mcd) at 20 mA	
	Min.	Max.
A9	14	17
A10	17	20
A11	20	24
A12	24	29
A13	29	35

Typical Electro-Optical Characteristics Curve

SIR(F) CHIP

Fig.1 Forward Current vs. Forward Voltage

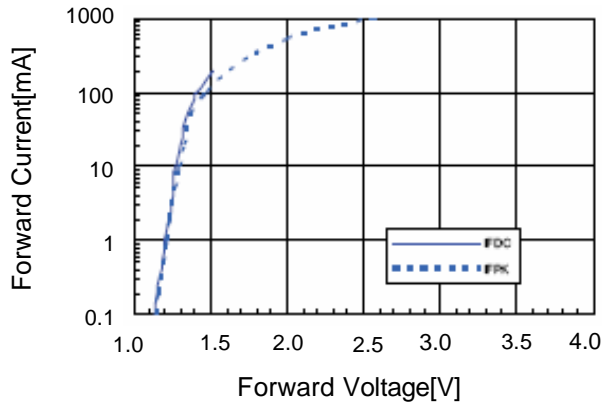

Fig.2 Relative Radiant Power vs. Wavelength

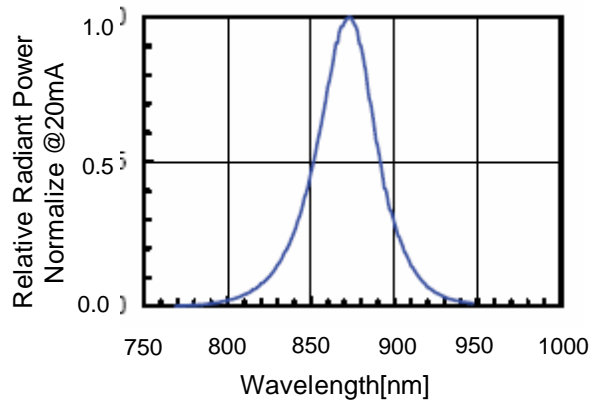

Fig.3 Relative Radiant Power vs. Forward DC Current

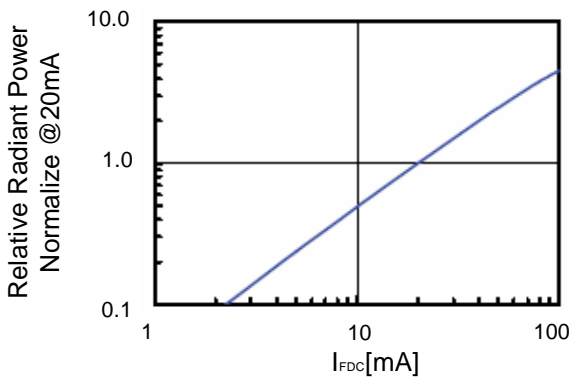

Fig.4 Relative Radiant Power vs. Forward Peak Current

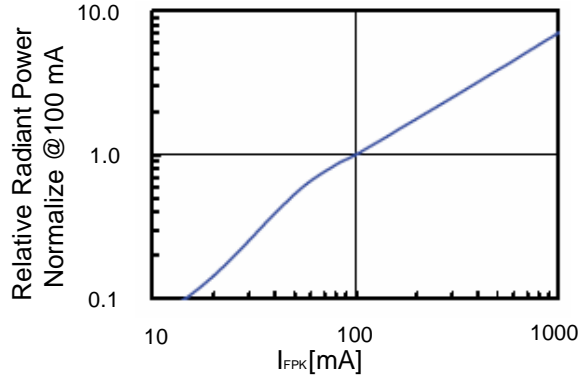

Fig.5 Forward DC Voltage vs. Temperature

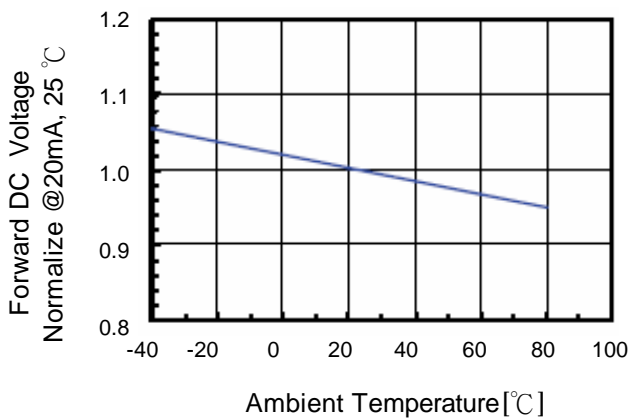
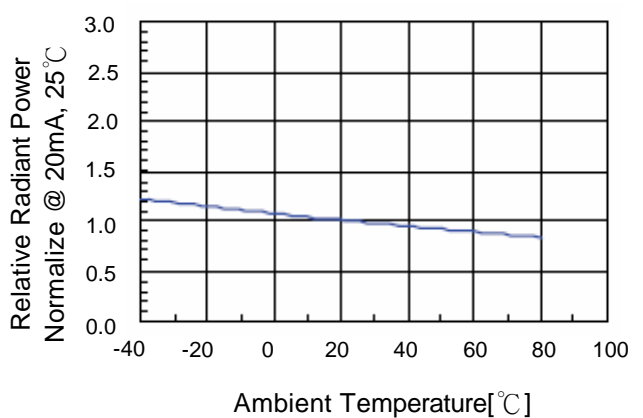

Fig.6 Relative Radiant Power vs. Temperature



Soldering Condition(Pb-Free)

1.Iron:

Soldering Iron:30W Max
Temperature 350° C Max
Soldering Time:3 Seconds Max(One Time)
Distance:2mm Min(From solder joint to body)

2.Wave Soldering Profile

Dip Soldering
Preheat: 120° C Max
Preheat time: 60seconds Max
Ramp-up
2° C/sec(max)
Ramp-Down:-5° C/sec(max)
Solder Bath:260° C Max
Dipping Time:3 seconds Max
Distance:2mm Min(From solder joint to body)

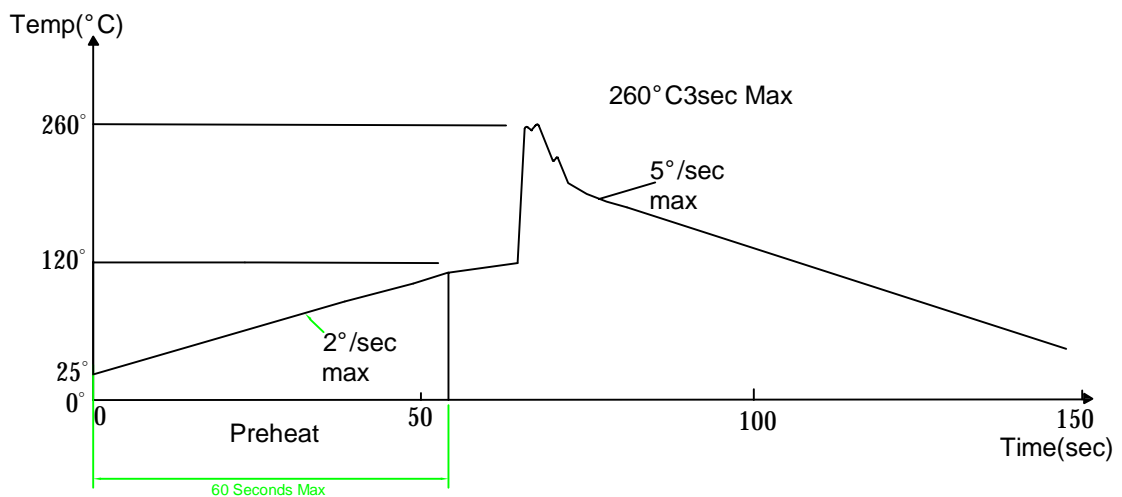

Recommended Soldering Conditions

3-1. LEAD Reflow Solder

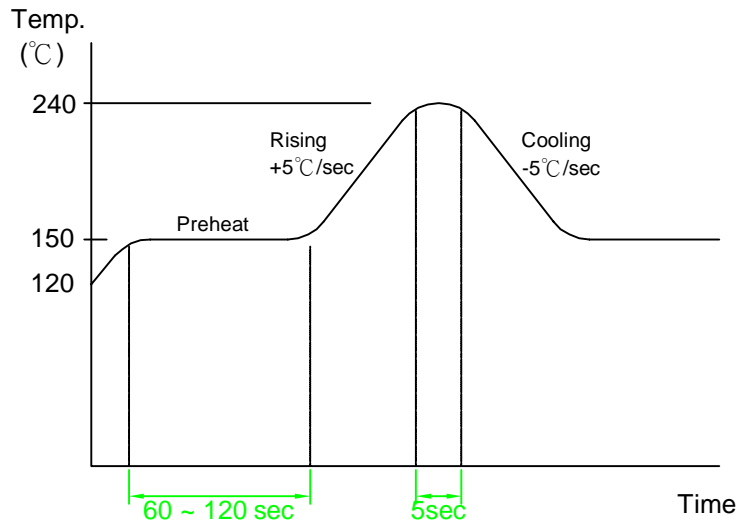

3-2 PB-Free Reflow Solder

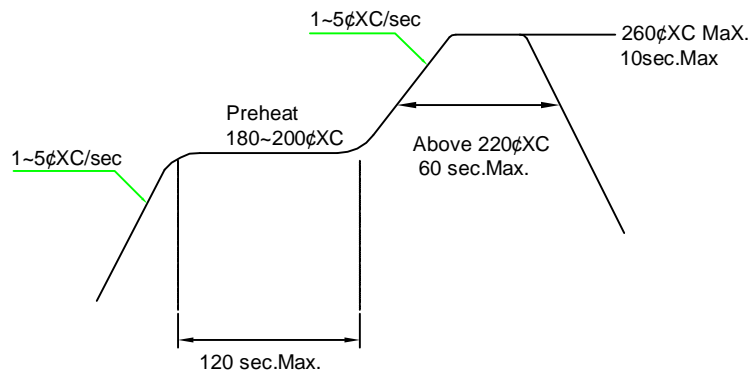

Reflow Soldering should not be done more than two times.

Reliability Test:

Test Item	Test Condition	Description	Reference Standard
Operating Life Test	1.Under Room Temperature 2.If=20mA 3.t=1000 hrs (-24hrs, +72hrs)	This test is conducted for the purpose of determining the resistance of a part in electrical and thermal stressed.	MIL-STD-750: 1026 MIL-STD-883: 1005 JIS C 7021: B-1
High Temperature Storage Test	1.Ta=105 °C±5°C 2.t=1000 hrs (-24hrs, +72hrs)	The purpose of this is the resistance of the device which is laid under condition of high temperature for hours.	MIL-STD-883:1008 JIS C 7021: B-10
Low Temperature Storage Test	1.Ta=-40 °C±5°C 2.t=1000 hrs (-24hrs, +72hrs)	The purpose of this is the resistance of the device which is laid under condition of low temperature for hours.	JIS C 7021: B-12
High Temperature High Humidity Test	1.Ta=65 °C±5°C 2.RH=90%~95% 3.t=240hrs ±2hrs	The purpose of this test is the resistance of the device under tropical for hours.	MIL-STD-202:103B JIS C 7021: B-11
Thermal Shock Test	1.Ta=105 °C±5°C & -40 °C±5°C (10min) (10min) 2.total 10 cycles	The purpose of this is the resistance of the device to sudden extreme changes in high and low temperature.	MIL-STD-202: 107D MIL-STD-750: 1051 MIL-STD-883: 1011
Solder Resistance Test	1.T.Sol=260 °C±5°C 2.Dwell time= 10 ±1sec.	This test intended to determine the thermal characteristic resistance of the device to sudden exposures at extreme changes in temperature when soldering the lead wire.	MIL-STD-202: 210A MIL-STD-750: 2031 JIS C 7021: A-1
Solderability Test	1.T.Sol=245 °C±5°C 2.Dwell time=5 ±1sec	This test intended to see soldering well performed or not.	MIL-STD-202: 208D MIL-STD-750: 2026 MIL-STD-883: 2003 JIS C 7021: A-2

1. 500PCS / BAG



2. 8 BAG / INNER BOX

SIZE : L X W X H 33.5cm X 19cm X 7.5cm

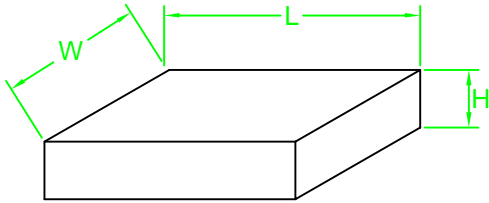

3. 12 INNER BOXES / CARTON

SIZE : L X W X H 58.5cm X 34cm X 34cm

