



LIGITEK

LIGITEK ELECTRONICS CO.,LTD.  
Property of Ligitek Only

---

SURFACE MOUNT TAPE AND REEL



Lead-Free Parts

**LSRF9033/TR2**

**DATA SHEET**

DOC. NO : QW0905-LSRF9033/TR2

REV. : A

DATE : 04 - Mar. - 2008



### Package Dimensions

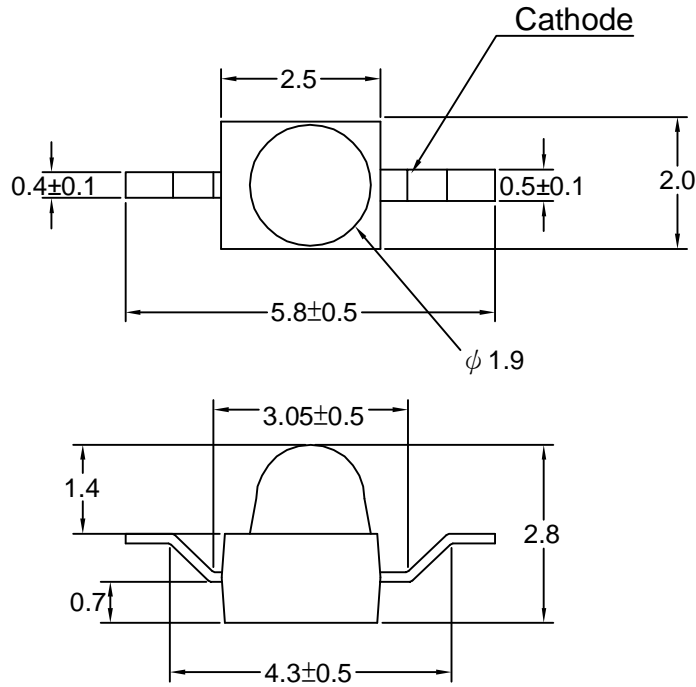

Note : 1.All dimension are in millimeter tolerance is ±0.2mm unless otherwise noted.  
2.Specifications are subject to change without notice.

### Carrier Type Dimensions

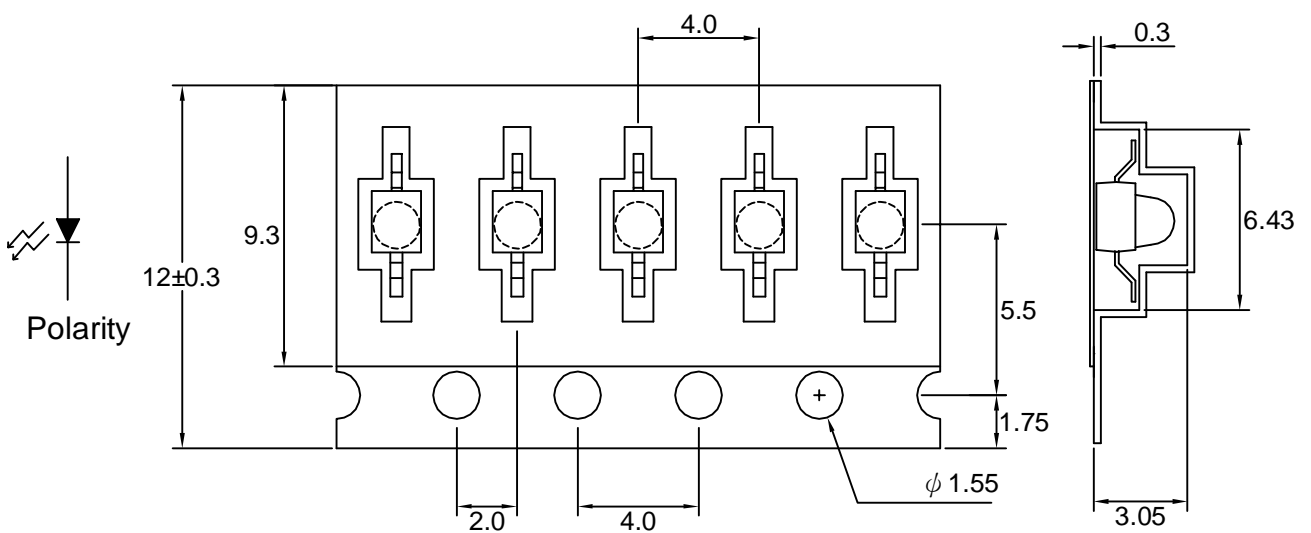

Note : The tolerances unless mentioned is ±0.2mm Unit=mm.



Reel Dimensions

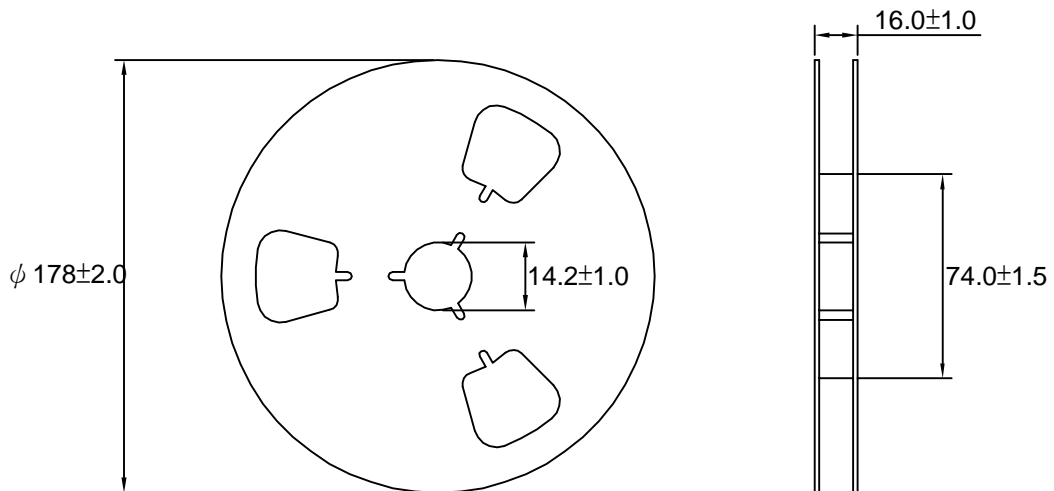

Part No.	Description	Quantity/Reel
LSRF9033/TR2	12.0mm tape,7"reel	1500 devices



## Absolute Maximum Ratings at Ta=25 °C

Parameter	Symbol	Ratings	UNIT
		SRF	
Forward Current	IF	30	mA
Peak Forward Current Duty 1/10@10KHz	IFP	90	mA
Power Dissipation	PD	75	mW
Reverse Current @5V	Ir	10	μA
Electrostatic Discharge( * )	ESD	2000	V
Operating Temperature	Topr	-40 ~ +85	°C
Storage Temperature	Tstg	-40 ~ +100	°C

\* Static Electricity or power surge will damage the LED. Use of a conductive wrist band or anti-electrostatic glove is recommended when handling these LED. All devices, equipment and machinery must be properly grounded.

## Typical Electrical &amp; Optical Characteristics (Ta=25 °C)

PART NO	MATERIAL	COLOR		Dominant wave length λ Dnm	Spectral halfwidth Δ λ nm	Forward voltage @20mA(V)		Luminous intensity @20mA(mcd)		Viewing angle 2θ 1/2 (deg)
		Emitted	Lens			Min.	Max.	Min.	Typ.	
LSRF9033/TR2	AlGaInP	Red	Water Clear	630	20	1.5	2.4	90	160	20

Note : 1.The forward voltage data did not including ±0.1V testing tolerance.  
2. The luminous intensity data did not including ±15% testing tolerance.



### Typical Electro-Optical Characteristics Curve

#### SRF CHIP

Fig.1 Forward current vs. Forward Voltage

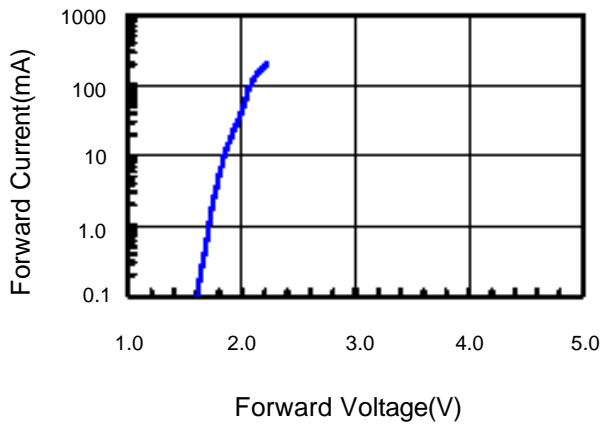

Fig.2 Relative Intensity vs. Forward Current

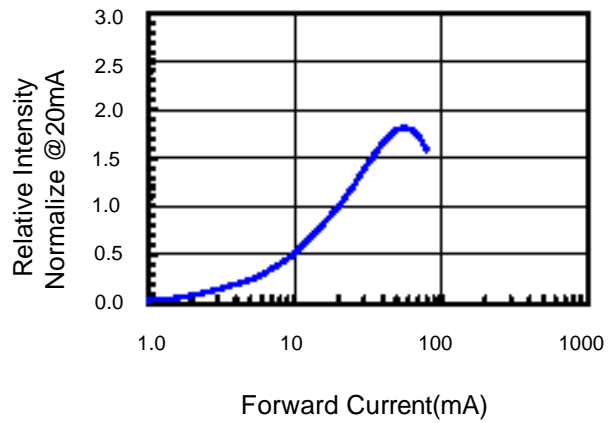

Fig.3 Forward Voltage vs. Temperature

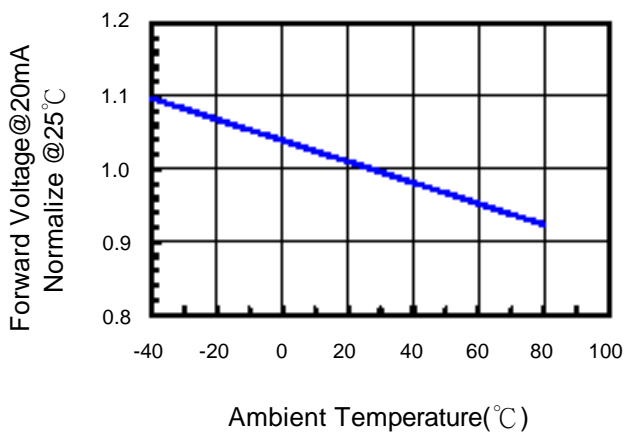

Fig.4 Relative Intensity vs. Temperature

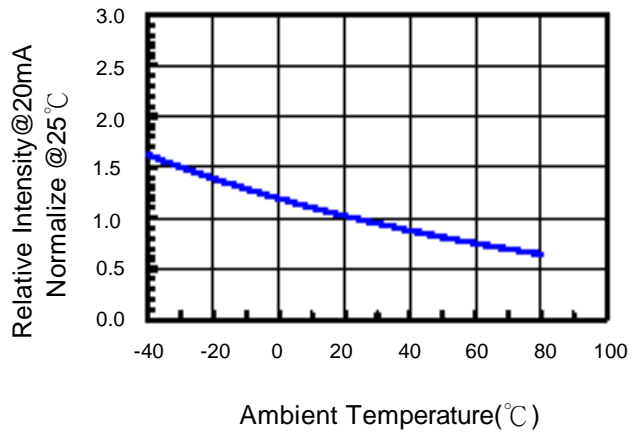

Fig.5 Relative Intensity vs. Wavelength

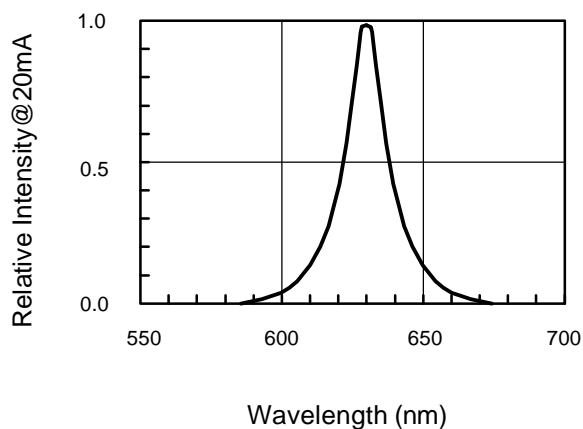
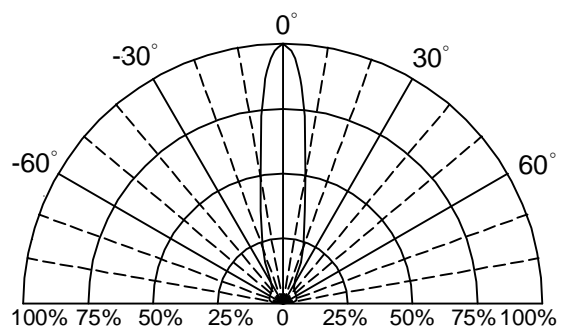

Fig.6 Directive Radiation





Recommended Soldering Conditions

1. Hand Solder

Basic spec is  $\leq 280^{\circ}\text{C}$  3 sec one time only.

2. Wave Solder

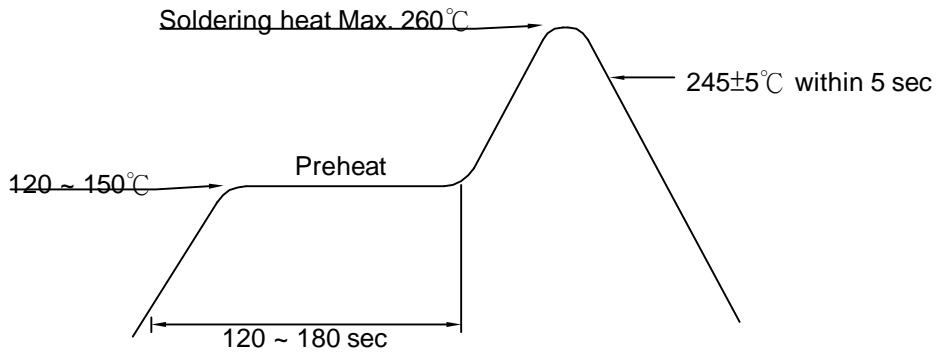

3. LEAD Reflow Solder

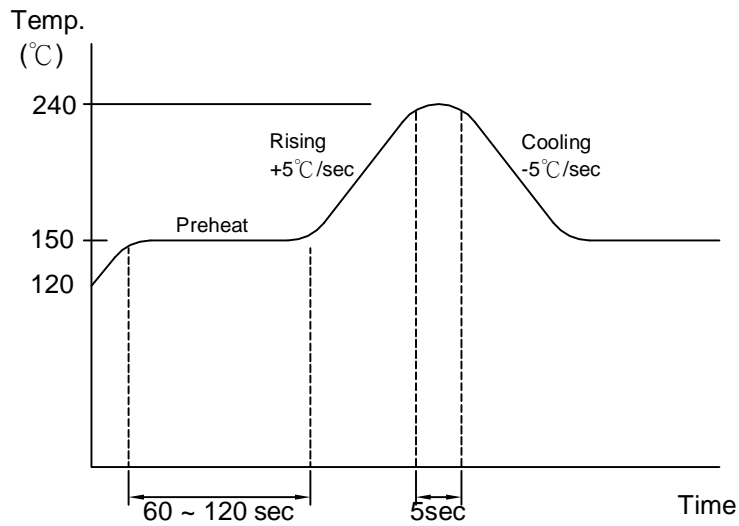

4. PB-Free Reflow Solder

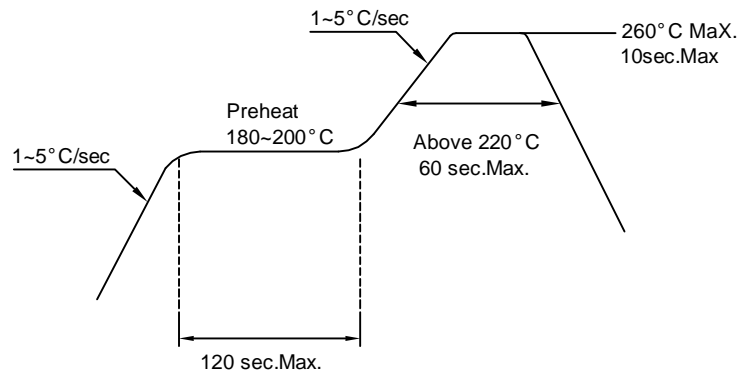

Note: 1. Wave solder and reflow soldering should not be made more than one time.  
2. You can just only select one of the soldering conditions as above.



**Precautions For Use:**

**Storage time:**

- 1.The operation of Temperatures and RH are :  $5^{\circ}\text{C} \sim 35^{\circ}\text{C}$  ,RH<60%.
- 2.Once the package is opened, the products should be used within a week. Otherwise, they should be kept in a damp proof box with desiccating agent. Considering the tape life, we suggest our customers to use our products within a year(from production date).
- 3.If opened more than one week in an atmosphere  $5^{\circ}\text{C} \sim 35^{\circ}\text{C}$  ,RH<60%, they should be treated at  $60^{\circ}\text{C} \pm 5^{\circ}\text{C}$  fo r 15hrs.

**Drive Method:**

LED is a current operated device, and therefore, requirer some kind of current limiting incorporated into the driver circuit. This current limiting typically takes the form of a current limiting resistor placed in series with the LED.

Consider worst case voltage variations than could occur across the current limiting resistor. The forwr d current should not be allowed to change by more than 40 % of its desired value.

Circuit model A

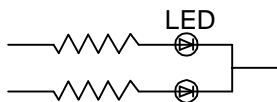

Circuit model B

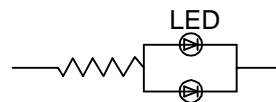

(A) Recommended circuit.

(B) The difference of brightness between LED could be found due to the VF-IF characteristics of LED.

**Cleaning:**

Use alcohol-based cleaning solvents such as isopropyl alcohol to clean the LED.

**ESD(Electrostatic Discharge):**

Static Electricity or power surge will damage the LED. Use of a conductive wrist band or anti-electrosatic glove is recommended when handing these LED. All devices, equipment and machinery must be properly grounded.



Reliability Test:

Classification	Test Item	Test Condition	Reference Standard
Endurance Test	Operating Life Test	1.Ta=Under Room Temperature As Per Data Sheet Maximum Rating. 2.If=20mA 3.t=1000 hrs (-24hrs, +72hrs)	MIL-STD-750D: 1026 MIL-STD-883D: 1005 JIS C 7021: B-1
	High Temperature Storage Test	1.Ta=105°C±5°C 2.t=1000 hrs (-24hrs, +72hrs)	MIL-STD-883D:1008 JIS C 7021: B-10
	Low Temperature Storage Test	1.Ta=-40°C±5°C 2.t=1000 hrs (-24hrs, +72hrs)	JIS C 7021: B-12
	High Temperature High Humidity Storage Test	1.Ta=65°C±5°C 2.RH=90%~95% 3.t=1000hrs ±2hrs	MIL-STD-202F:103B JIS C 7021: B-11
Environmental Test	Thermal Shock Test	1.Ta=105°C±5°C & -40°C±5°C (10min) (10min) 2.total 10 cycles	MIL-STD-202F: 107D MIL-STD-750D: 1051 MIL-STD-883D: 1011
	Solderability Test	1.T.Sol=235°C±5°C 2.Immersion time 2 ±0.5sec 3.Coverage ≥95% of the dipped surface	MIL-STD-202F: 208D MIL-STD-750D: 2026 MIL-STD-883D: 2003 IEC 68 Part 2-20 JIS C 7021: A-2
	Temperature Cycling	1.105°C ~ 25°C ~ -55°C ~ 25°C 30mins 5mins 30mins 5mins 2.10 Cyeles	MIL-STD-202F: 107D MIL-STD-750D: 1051 MIL-STD-883D: 1010 JIS C 7021: A-4
	IR Reflow	1.T=260φXC Max. 10sec.Max. 2. 6 Min	MIL-STD-750D:2031.2 J-STD-020