

**ROUND TYPE LED LAMPS**



Lead-Free Parts

**LWK2043/A-B02**

**DATA SHEET**

DOC. NO : QW0905-LWK2043/A-B02

REV. : A

DATE : 11 -Mar. - 2016



Package Dimensions

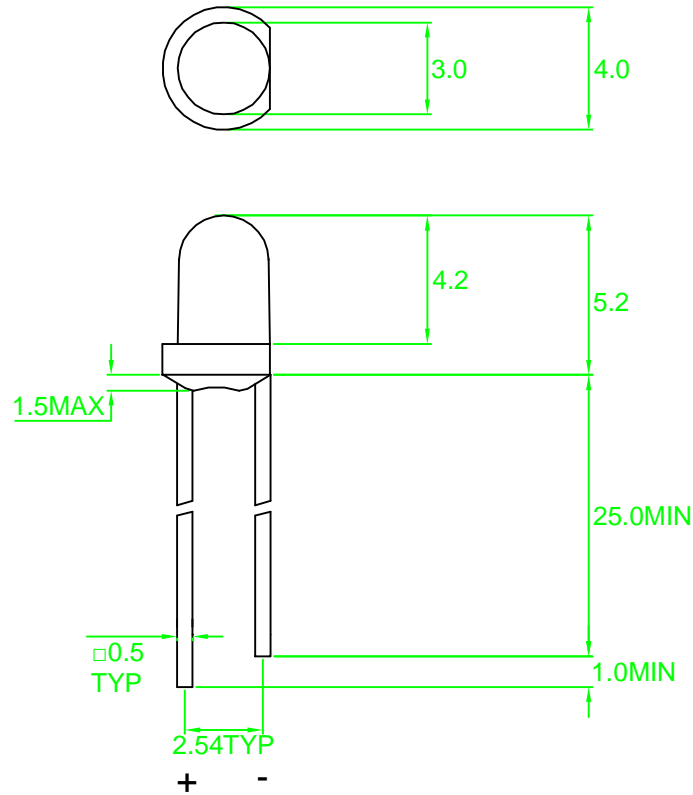

Note : 1.All dimension are in millimeter tolerance is  $\pm 0.25\text{mm}$  unless otherwise noted.  
2.Specifications are subject to change without notice.

Directivity Radiation

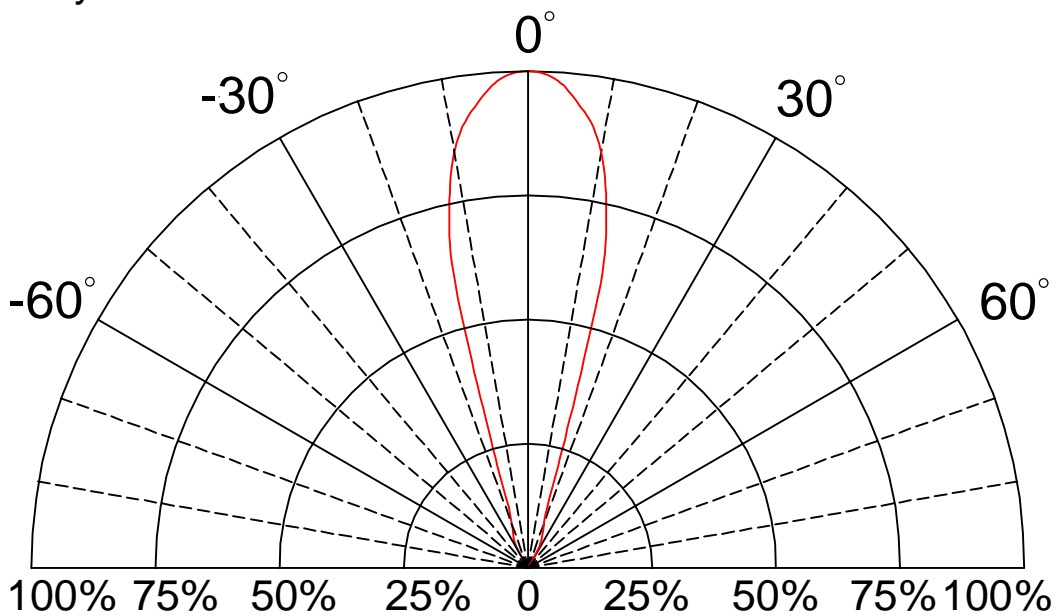

Absolute Maximum Ratings at Ta=25 °C

Parameter	Symbol	Ratings	UNIT
		WK	
Forward Current	IF	30	mA
Peak Forward Current Duty 1/10@10KHz	IFP	100	mA
Power Dissipation	PD	120	mW
Reverse Current @5V	Ir	50	μA
Electrostatic Discharge( * )	ESD	500	V
Operating Temperature	Topr	-20~ +80	°C
Storage Temperature	Tstg	-30~ +100	°C

Typical Electrical & Optical Characteristics (Ta=25 °C)

PART NO	MATERIAL	COLOR		Chromaticity Coordinates (Typ.)		Forward voltage @20mA(V)		Luminous intensity @20mA(mcd)		Viewing angle 2θ 1/2 (deg)
		Emitted	Lens	X	Y	Typ.	Max.	Min.	Typ.	
LWK2043/A-B02	In/GaN	White	Water Clear	0.28	0.28	3.5	4.0	3400	6200	30

Note : 1.The forward voltage data did not including ±0.1V testing tolerance.  
2. The luminous intensity data did not including ±15% testing tolerance.

## Brightness Code For Standard LED Lamps

WK CHIP

Group	Luminous Intensity(mcd) at 20mA	
	Min.	Max.
A27	3400	4000
A28	4000	5000
A29	5000	6200
A30	6200	7700
A31	7700	9500
A32	9500	11500

. Chromaticity Coordinates Specifications for Bin Grading

BIN	X	Y	BIN	X	Y	BIN	X	Y
A1	0.21	0.190	B1	0.26	0.265	C1	0.31	0.340
	0.21	0.150		0.26	0.225		0.31	0.300
	0.22	0.165		0.27	0.240		0.32	0.315
	0.22	0.205		0.27	0.280		0.32	0.355
A2	0.22	0.205	B2	0.27	0.280	C2	0.32	0.355
	0.22	0.165		0.27	0.240		0.32	0.315
	0.23	0.180		0.28	0.255		0.33	0.330
	0.23	0.220		0.28	0.295		0.33	0.370
A3	0.23	0.220	B3	0.28	0.295	C3	0.33	0.370
	0.23	0.180		0.28	0.255		0.33	0.330
	0.24	0.195		0.29	0.270		0.34	0.345
	0.24	0.235		0.29	0.310		0.34	0.385
A4	0.24	0.235	B4	0.29	0.310	C4	0.34	0.385
	0.24	0.195		0.29	0.270		0.34	0.345
	0.25	0.210		0.30	0.285		0.35	0.360
	0.25	0.250		0.30	0.325		0.35	0.400
A5	0.25	0.250	B5	0.30	0.325			
	0.25	0.210		0.30	0.285			
	0.26	0.225		0.31	0.300			
	0.26	0.265		0.31	0.340			

. CIE Chromaticity Diagram

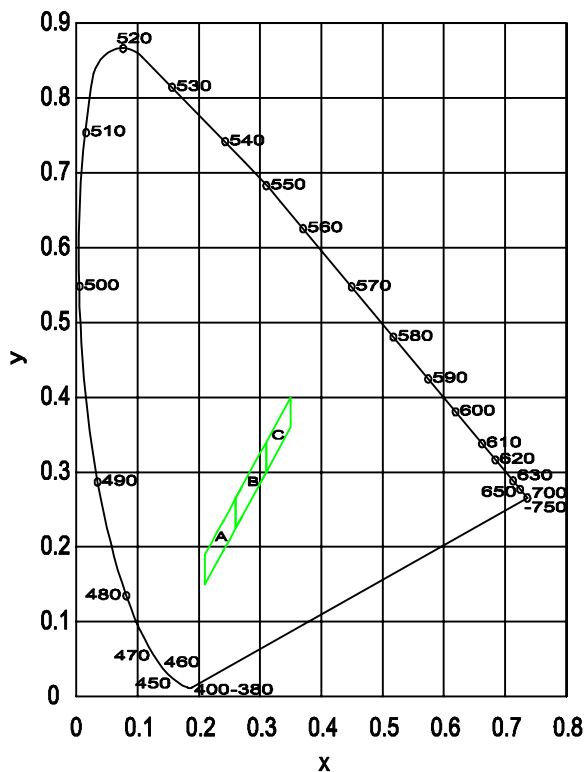

## Typical Electro-Optical Characteristics Curve

WK CHIP

Fig.1 Forward current vs. Forward Voltage

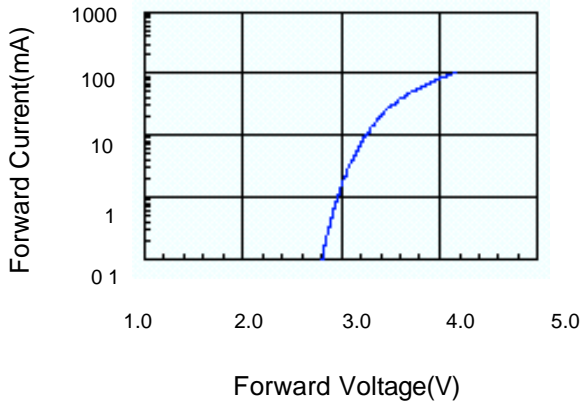

Fig.2 Relative Intensity vs. Forward Current

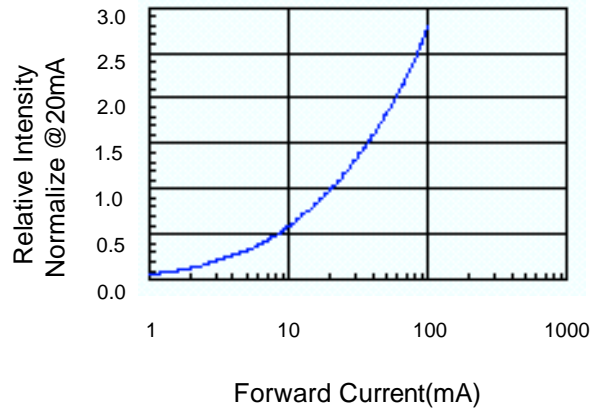

Fig.3 Forward Voltage vs. Temperature

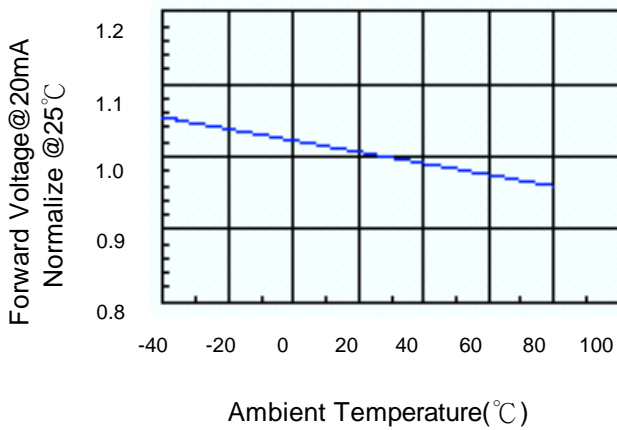

Fig.4 Relative Intensity vs. Temperature

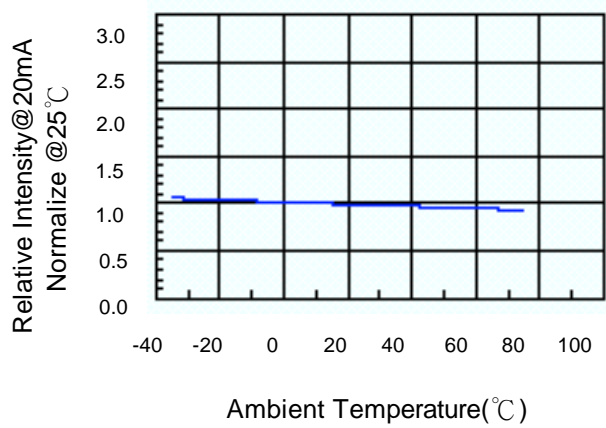
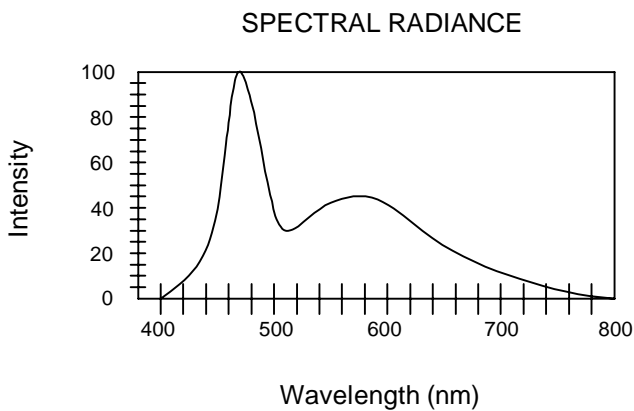

Fig.5 Luminous Spectrum (Ta=25°C)



**Soldering Condition(Pb-Free)****1.Iron:**

Soldering Iron:30W Max  
Temperature 350 °C Max  
Soldering Time:3 Seconds Max(One time only)  
Distance:2mm Min(From solder joint to body)

**2.Wave Soldering Profile**

Dip Soldering  
Preheat: 120° C Max  
Preheat time: 60seconds Max  
Ramp-up  
2° C/sec(max)  
Ramp-Down:-5° C/sec(max)  
Solder Bath:260° C Max  
Dipping Time:3 seconds Max  
Distance:2mm Min(From solder joint to body)

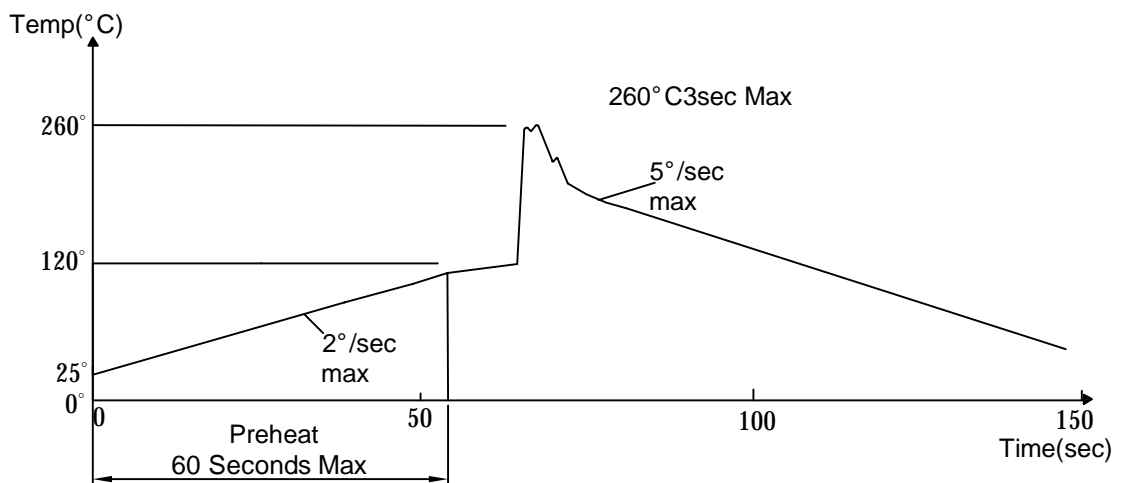

Note: 1.Wave solder should not be made more than one time.  
2.You can just only select one of the soldering conditions as above.

### Reliability Test:

Test Item	Test Condition	Description	Reference Standard
Operating Life Test	1.Under Room Temperature 2.If=20mA 3.t=1000 hrs (-24hrs, +72hrs)	This test is conducted for the purpose of determining the resistance of a part in electrical and thermal stressed.	MIL-STD-750: 1026 MIL-STD-883: 1005 JIS C 7021: B-1
High Temperature Storage Test	1.Ta=105 °C ±5°C 2.t=1000 hrs (-24hrs, +72hrs)	The purpose of this is the resistance of the device which is laid under condition of high temperature for hours.	MIL-STD-883:1008 JIS C 7021: B-10
Low Temperature Storage Test	1.Ta=-40 °C ±5°C 2.t=1000 hrs (-24hrs, +72hrs)	The purpose of this is the resistance of the device which is laid under condition of low temperature for hours.	JIS C 7021: B-12
High Temperature High Humidity Test	1.Ta=65 °C ±5°C 2.RH=90 %~95% 3.t=240hrs ±2hrs	The purpose of this test is the resistance of the device under tropical for hours.	MIL-STD-202:103B JIS C 7021: B-11
Thermal Shock Test	1.Ta=105 °C ±5°C & -40 °C ±5°C (10min) (10min) 2.total 10 cycles	The purpose of this is the resistance of the device to sudden extreme changes in high and low temperature.	MIL-STD-202: 107D MIL-STD-750: 1051 MIL-STD-883: 1011
Solder Resistance Test	1.T.Sol=260 °C ±5°C 2.Dwell time= 10 ±1sec.	This test intended to determine the thermal characteristic resistance of the device to sudden exposures at extreme changes in temperature when soldering the lead wire.	MIL-STD-202: 210A MIL-STD-750: 2031 JIS C 7021: A-1
Solderability Test	1.T.Sol=230 °C ±5°C 2.Dwell time=5 ±1sec	This test intended to see soldering well performed or not.	MIL-STD-202: 208D MIL-STD-750: 2026 MIL-STD-883: 2003 JIS C 7021: A-2



1. 1000 PCS / BAG

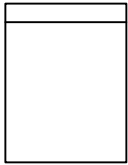

2. 8 BAG / INNER BOX

SIZE : L X W X H 33.5cm X 19cm X 7.5cm

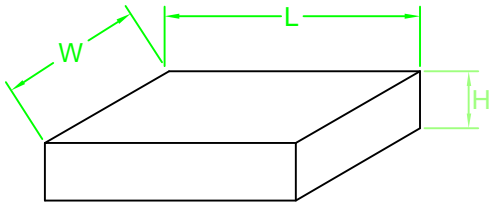

3. 12 INNER BOXES / CARTON

SIZE : L X W X H 58.5cm X 34cm X 34cm

