

DUAL DIGIT SMD DISPLAY(0.20")



LSDD205/6DGM-XX

DATA SHEET

DOC.NO : QW0905- LSDD205/6DGM-XX

REV. : A

DATE : 23 -Jan. - 2019



Package Dimensions

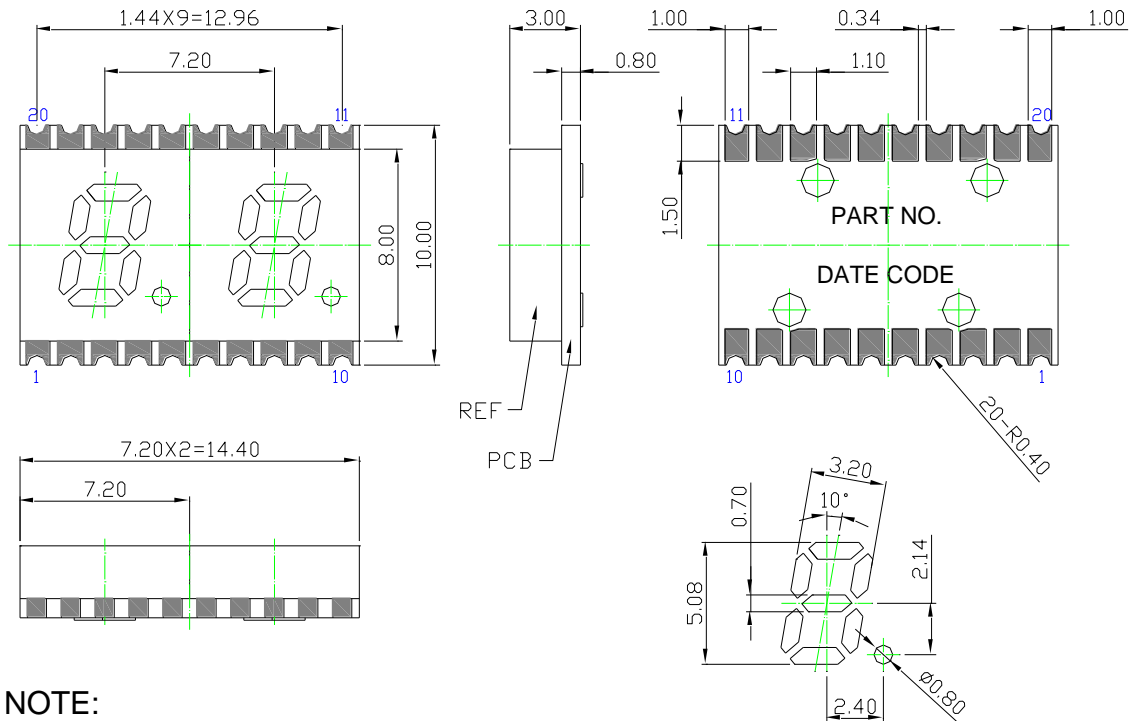

NOTE:
Dimension in millimeter (inch),
And tolerance is ± 0.25 (.01) specified.

Recommended Soldering Pad Dimensions

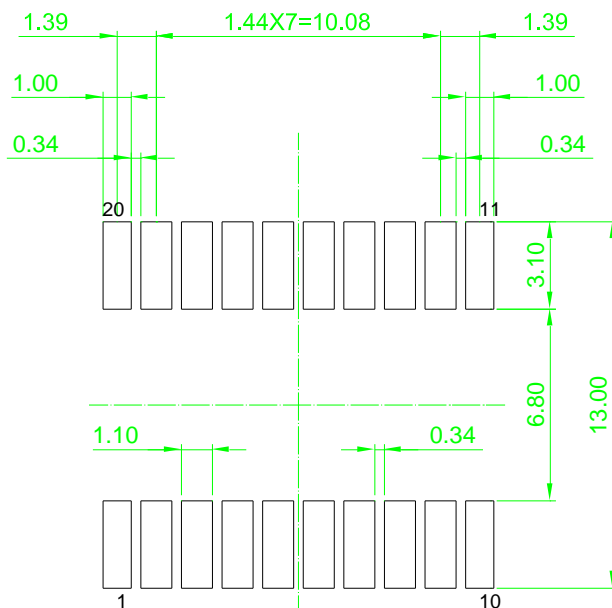

Internal Circuit Diagram

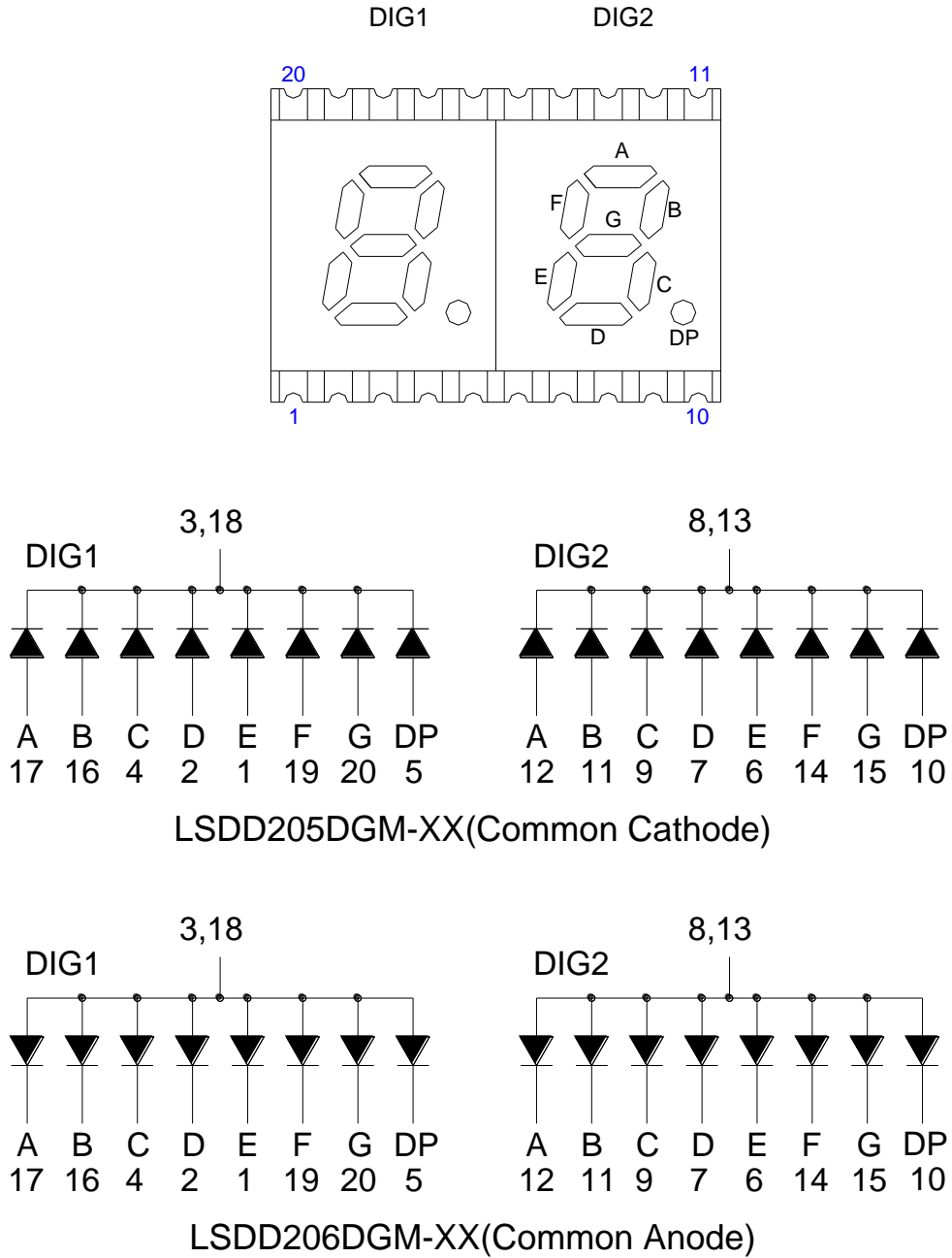

Electrical Connection

PIN NO.	LSDD205DGM-XX	PIN NO.	LSDD206DGM-XX
1	Anode DIG1 E	1	Cathode DIG1 E
2	Anode DIG1 D	2	Cathode DIG1 D
3	Common Cathode DIG1	3	Common Anode DIG1
4	Anode DIG1 C	4	Cathode DIG1 C
5	Anode DIG1 DP	5	Cathode DIG1 DP
6	Anode DIG2 E	6	Cathode DIG2 E
7	Anode DIG2 D	7	Cathode DIG2 D
8	Common Cathode DIG2	8	Common Anode DIG2
9	Anode DIG2 C	9	Cathode DIG2 C
10	Anode DIG2 DP	10	Cathode DIG2 DP
11	Anode DIG2 B	11	Cathode DIG2 B
12	Anode DIG2 A	12	Cathode DIG2 A
13	Common Cathode DIG2	13	Common Anode DIG2
14	Anode DIG2 F	14	Cathode DIG2 F
15	Anode DIG2 G	15	Cathode DIG2 G
16	Anode DIG1 B	16	Cathode DIG1 B
17	Anode DIG1 A	17	Cathode DIG1 A
18	Common Cathode DIG1	18	Common Anode DIG1
19	Anode DIG1 F	19	Cathode DIG1 F
20	Anode DIG1 G	20	Cathode DIG1 G

Absolute Maximum Ratings at Ta=25°C

Parameter	Symbol	Ratings	UNIT
Power Dissipation	PD	120	mW
Peak pulse current Duty 1/10@10KHz	I _{FP}	100	mA
Forward Current Per Chip	I _F	30	mA
Storage Temperature	T _{stg}	-40 ~ +105	°C
Operating Temperature	T _{opr}	-40 ~ +105	°C

Typical Electrical & Optical Characteristics (Ta=25°C)

Parameter	Symbol	Min.	Typ.	Max.	Unit	Condition
Luminous Intensity	IV	130	----	280	mcd	IF=20mA
Dominant Wavelength	λ D	515	----	530	nm	IF=20mA
Spectral Line Half-Width	Δ P	----	30	----	nm	IF=20mA
Forward Voltage	VF	----	2.8	3.2	V	IF=20mA
Reverse Current	I _r	----	----	10	μ A	VR=5V

Note : 1.The forward voltage data did not including $\pm 0.1V$ testing tolerance.

2.The luminous intensity data did not including $\pm 15\%$ testing tolerance.

Luminous Intensity Classification

BIN CODE	Iv(mcd) at 20mA	
	Min	Max
R	130	180
S	180.1	230
T	230.1	280

Dominant Wavelength Classification

BIN CODE	Wd(nm) at 20mA	
	Min	Max
1	515	520
2	520.1	525
3	525.1	530

Typical Electro-Optical Characteristics Curve

(25 °C Free Air Temperature Unless Otherwise Specified)

DGM: Super Bright RED (AlGaInP/GaAs) CURVE

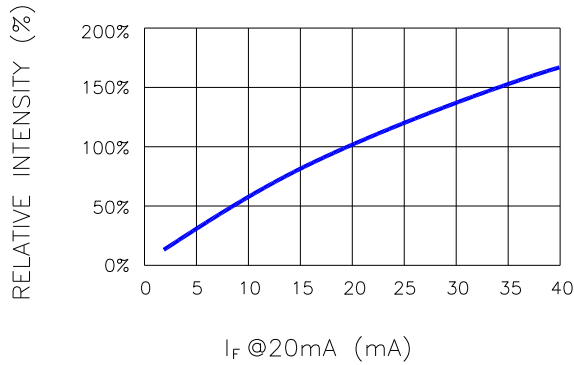

Fig.1 RELATIVE INTENSITY VS. FORWARD CURRENT

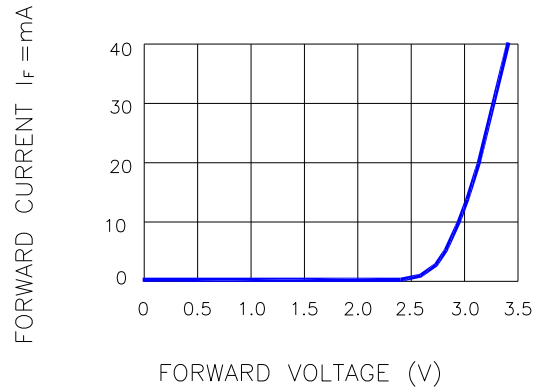

Fig.2 FORWARD CURRENT VS. FORWARD VOLTAGE

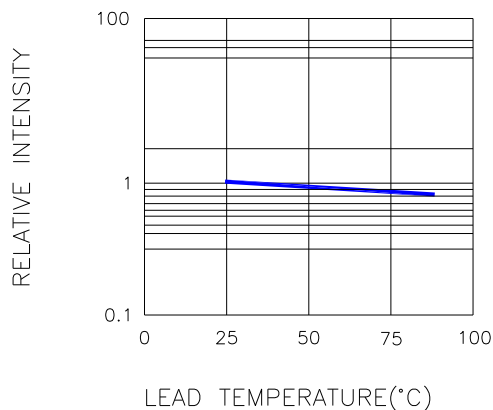

Fig.3 RELATIVE INTENSITY VS. LEAD TEMPERATURE
(PULSED 20 mA; 300us PULSE, 10ms PERIOD)

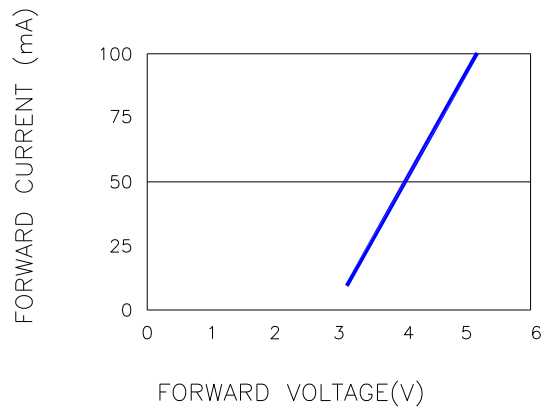

Fig.4 PEAK FORWARD VOLTAGE VS. FORWARD CURRENT
(100us TEST PULSE, 1% DUTY CYCLE)

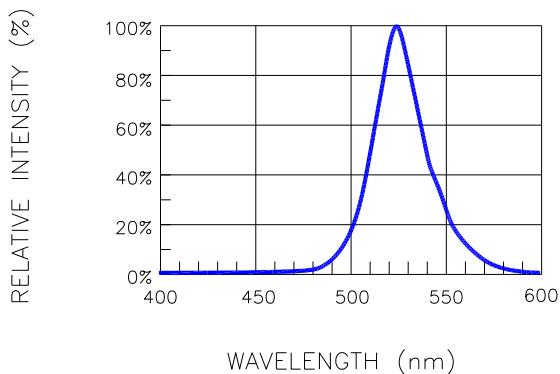

Fig.5 RELATIVE INTENSITY VS. WAVELENGTH

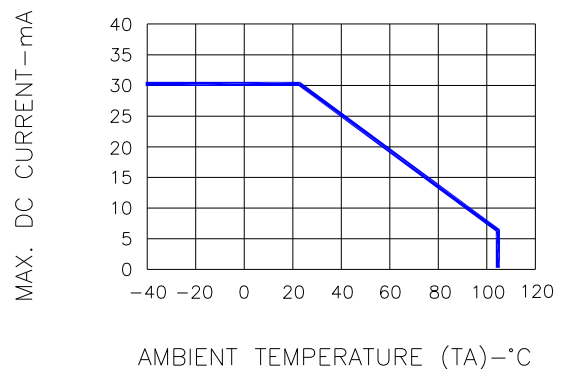
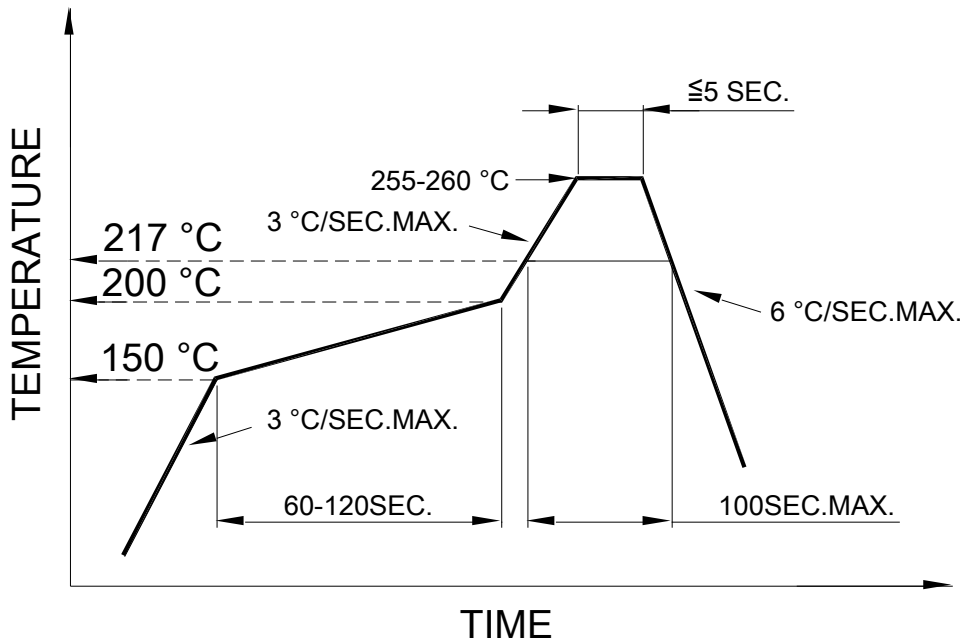

Fig.6 MAX. ALLOWABLE DC CURRENT VS. AMBIENT TEMPERATURE

SMT REFLOW SOLDERING INSTRUCTIONS

SMT Soldering Profile

Pb free reflow soldering Profile



SOLDERING IRON

Basic spec is ≤ 4 sec when 260°C. If temperature is higher, time should be shorter (+10°C→1 sec). Power dissipation of Iron should be smaller than 15W, and temperature should be controllable. Surface temperature of the device should be under 230°C.

REWORK

Customer must finish rework within 3 sec. under 350°C.

The head of soldering iron cannot touch copper foil.

● STORAGED CONDITION

In factory original sealed bag package

TEMPERATURE CONDITION	HUMIDITY CONDITION
5°C ~ 30°C	Below 60%RH

After opened and not in factory original sealed bag package

TEMPERATURE CONDITION	HUMIDITY CONDITION	STORAGE TIME
5°C ~ 30°C	Below 60%RH	Within 4 weeks (MSL as level 2a)

REEL DIMENSIONS

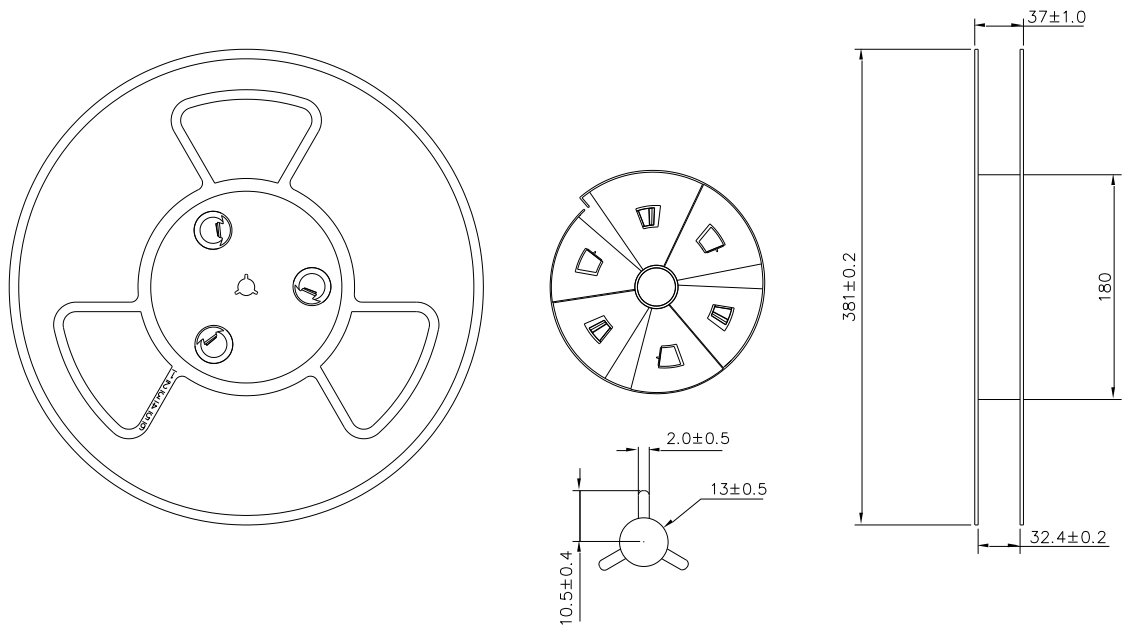

PACKING & LABEL SPECIFICATIONS

