

Single DIGIT SMD DISPLAY (0.56")

LSSD515/63V-XX

DATA SHEET

DOC.NO : QW0905- LSSD515/63V-XX

REV. : A

DATE : 15 – Apr. – 2013



Package Dimensions

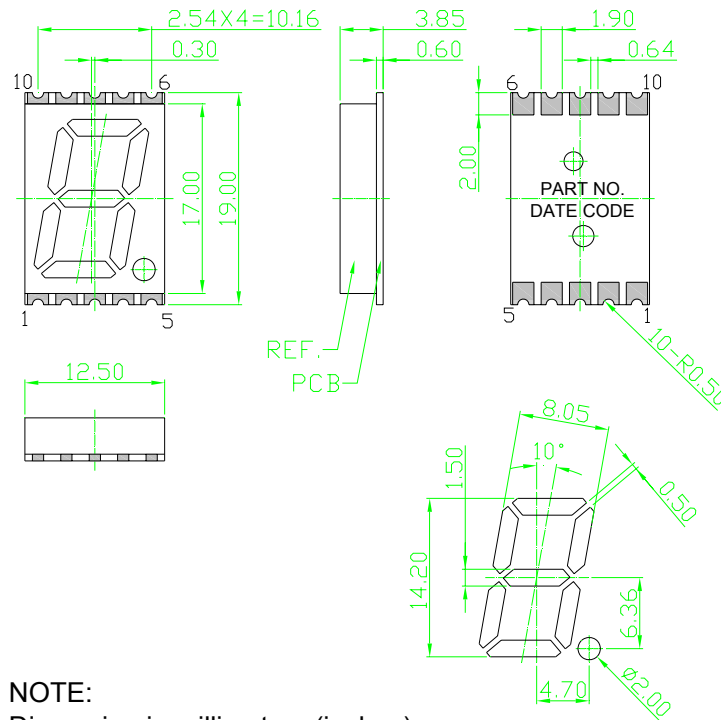

NOTE:
Dimension in millimeters (inches),
and tolerances are $\pm 0.25\text{mm}$ (.01") specified.

Recommended Soldering Pad Dimensions

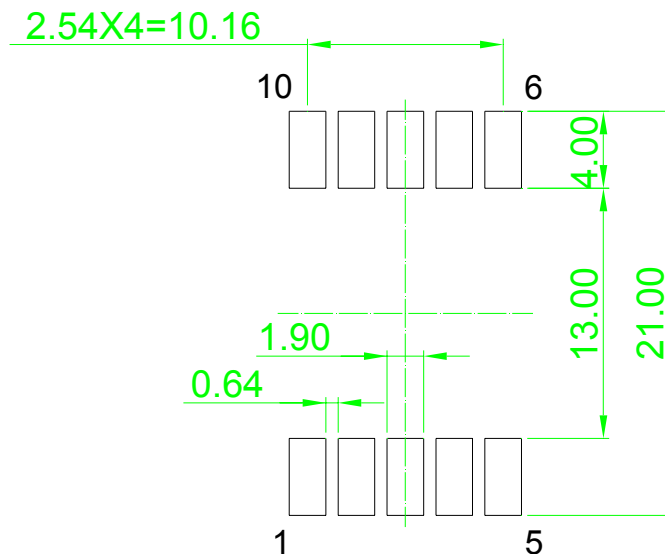

Internal Circuit Diagram

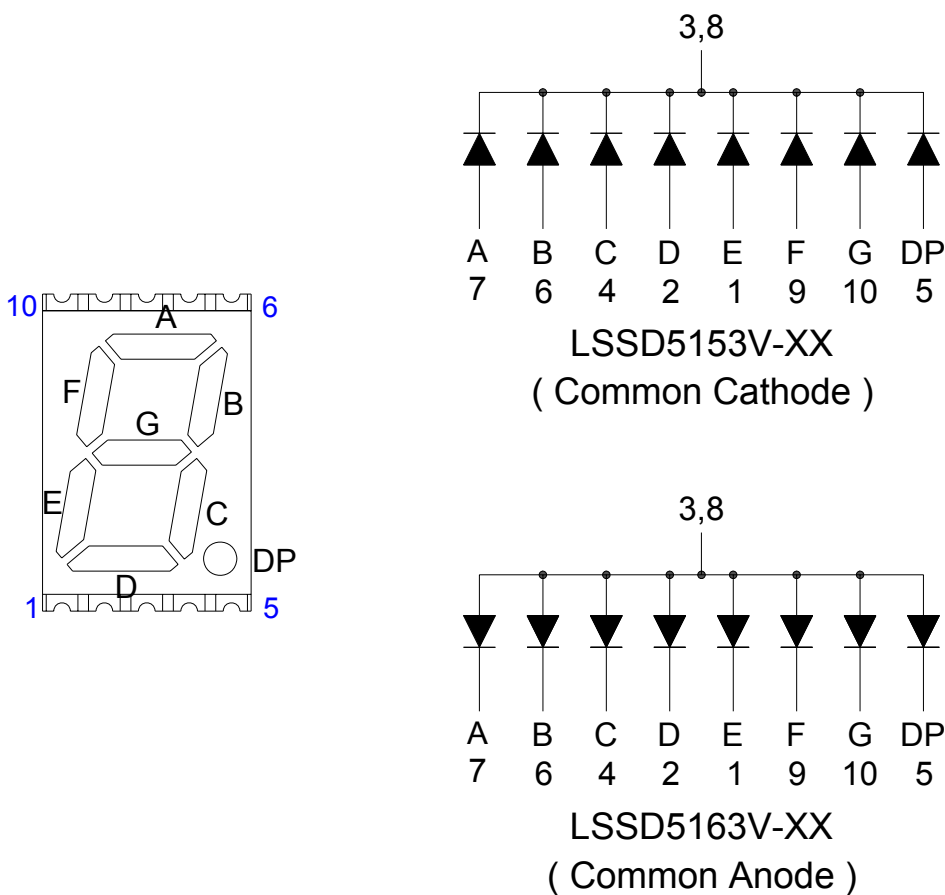

Electrical Connection

PIN NO.	LSSD5153V-XX	PIN NO.	LSSD5163V-XX
1	Anode E	1	Cathode E
2	Anode D	2	Cathode D
3	Common Cathode	3	Common Anode
4	Anode C	4	Cathode C
5	Anode DP	5	Cathode DP
6	Anode B	6	Cathode B
7	Anode A	7	Cathode A
8	Common Cathode	8	Common Anode
9	Anode F	9	Cathode F
10	Anode G	10	Cathode G

Absolute Maximum Ratings at Ta=25°C

Parameter	Symbol	Ratings	UNIT
Power Dissipation	PD	70	mW
Peak pulse current Duty 1/10@10KHz	I _{FP}	90	mA
Forward Current Per Chip	I _F	25	mA
Debating liner from 25°C per segment	---	0.28	mA / °C
Storage Temperature	T _{stg}	-40 ~ +105	°C
Operating Temperature	T _{opr}	-40 ~ +105	°C

Typical Electrical & Optical Characteristics (Ta=25°C)

Parameter	Symbol	Min.	Typ.	Max.	Unit	Condition
Luminous Intensity	IV	---	20	----	mcd	IF=20mA
Dominant Wavelength	λ D	----	590	----	nm	IF=20mA
Spectral Line Half-Width	ΔP	----	25	----	nm	IF=20mA
Forward Voltage	VF	----	2.0	2.6	V	IF=20mA
Reverse Current	I _r	----	----	10	μ A	VR=5V

Note : 1.The forward voltage data did not including ±0.1V testing tolerance.

2.The luminous intensity data did not including ±15% testing tolerance.

Typical Electro-Optical Characteristics Curve

(25 °C Free Air Temperature Unless Otherwise Specified)

3V: Super Bright Yellow (AlGaInP/GaAs) CURVE

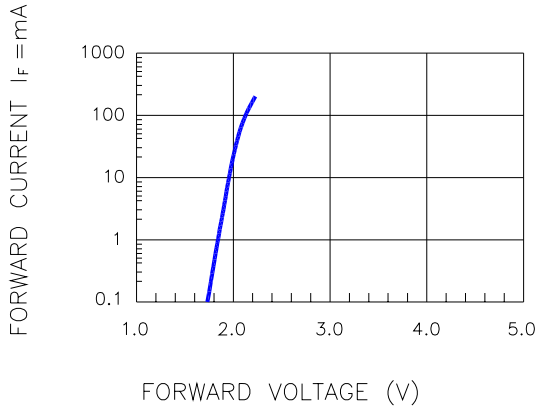

Fig.1 FORWARD CURRENT VS. FORWARD VOLTAGE

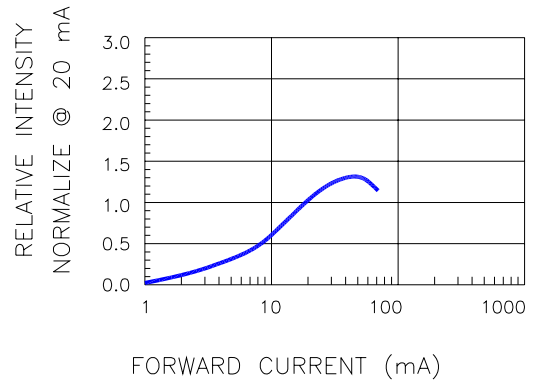

Fig.2 RELATIVE INTENSITY VS. FORWARD CURRENT

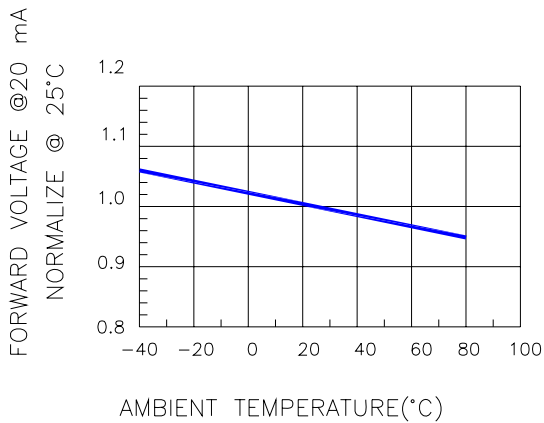

Fig.3 FORWARD VOLTAGE VS. TEMPERATURE

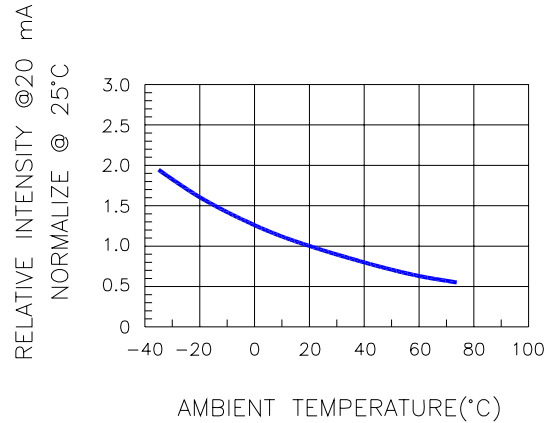

Fig.4 RELATIVE INTENSITY VS. TEMPERATURE

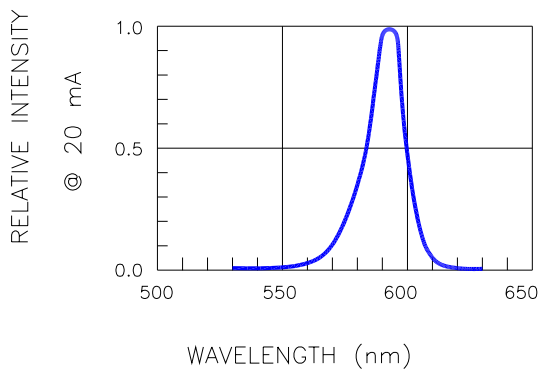

Fig.5 RELATIVE INTENSITY VS. WAVELENGTH

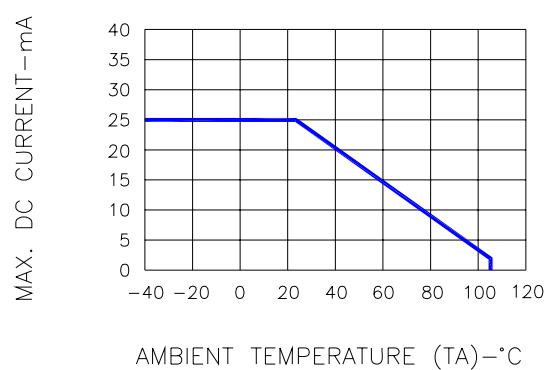
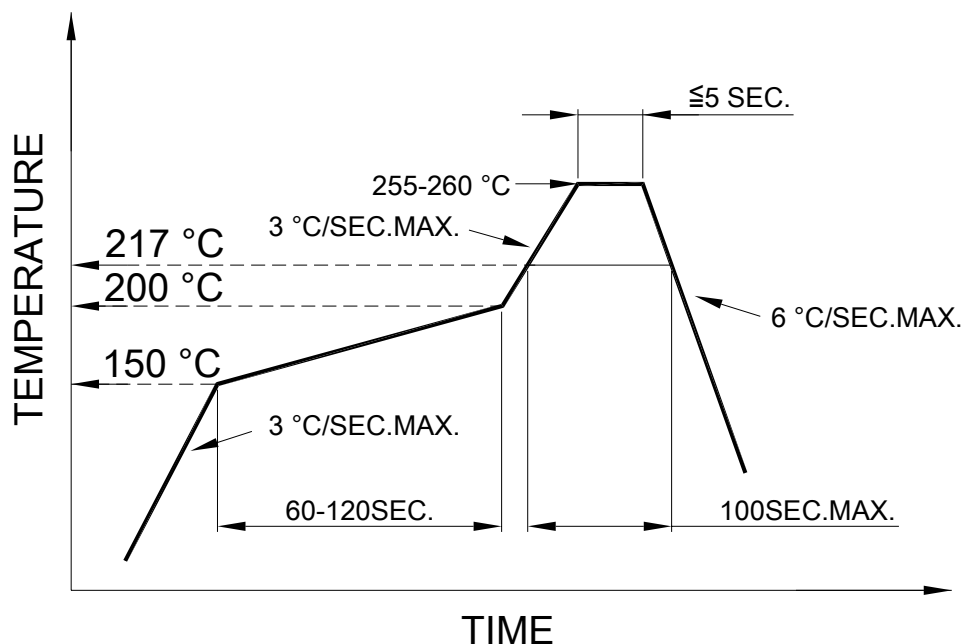

Fig.6 MAX. ALLOWABLE DC CURRENT VS. AMBIENT TEMPERATURE

SMT REFLOW SOLDERING INSTRUCTIONS

SMT Soldering Profile

Pb free reflow soldering Profile



SOLDERING IRON

Basic spec is ≤ 4 sec when 260°C. If temperature is higher, time should be shorter (+10°C→1 sec). Power dissipation of Iron should be smaller than 15W, and temperature should be controllable. Surface temperature of the device should be under 230°C.

REWORK

Customer must finish rework within 3 sec. under 350°C.

The head of soldering iron cannot touch copper foil.