



LIGITEK ELECTRONICS CO.,LTD.  
Property of Ligitek Only

LED SMD



Lead-Free Parts

LG-197RGB-C-CT-3C1-B01

## DATA SHEET

DOC. NO : QW0905-LG-197RGB-C-CT-3C1-B01

REV. : A

DATE : 27 - Jun. - 2017



**Features:**

1. Package in 8.0mm carrier tape on 7" diameter reel.
2. Compatible with automatic placement equipment.
3. Compatible with infrared and vapor phase reflow solder process.

**Descriptions:**

1. The LG-197 SMD Taping is much smaller than lead frame type components, thus enable smaller board size, higher packing density, reduced storage space and finally smaller equipment to be obtained.
2. Besides, lightweight makes them ideal for miniature applications. etc.

**Applications:**

1. Automotive : backlighting in dashboard and switch.
2. Telecommunication : indicator and backlighting in telephone and fax.
3. Flat backlight for LCD, switch and symbol
4. General use.

**Device Selection Guide:**

PART NO	MATERIAL	COLOR	
		Emitted	Lens
LG-197RGB-C-CT-3C1-B01	AlGaInP	Red	Water Clear
	InGaN	Green	
	InGaN	Blue	

## Package Dimensions

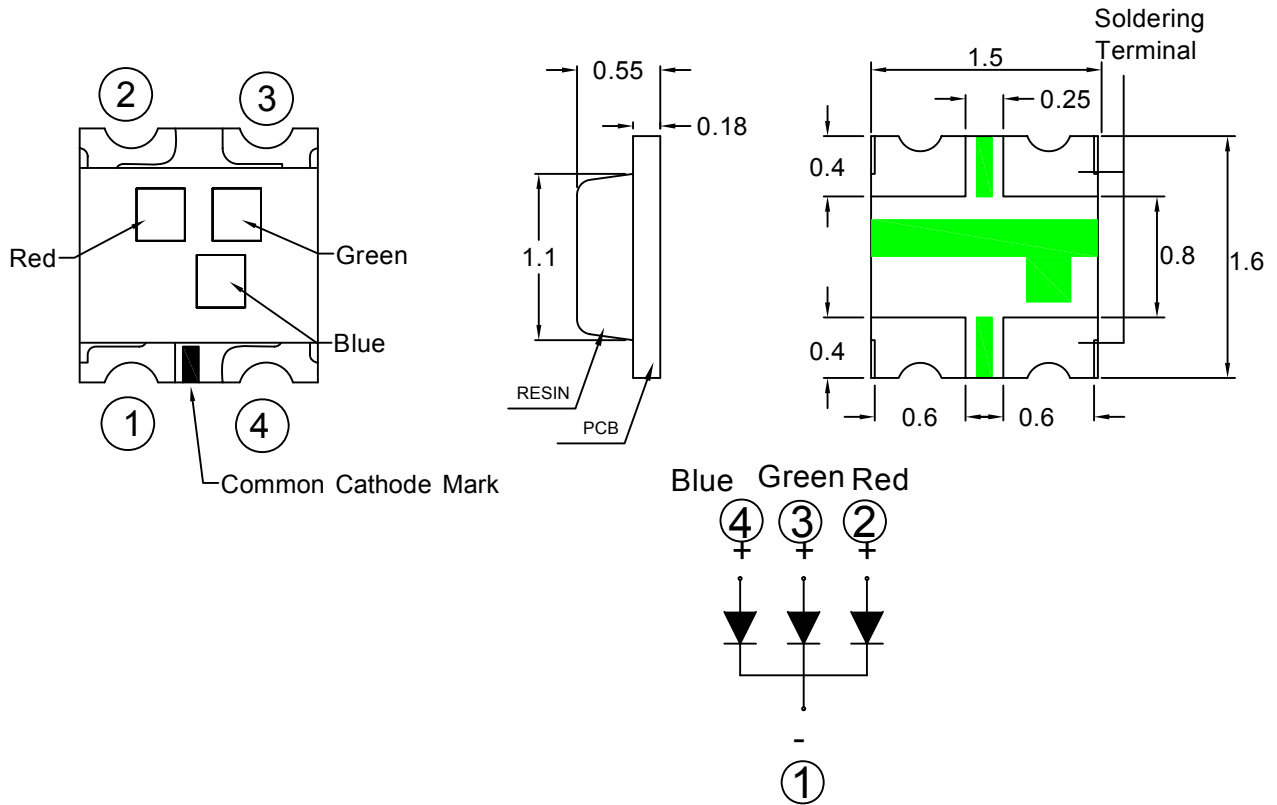

Note : 1.All dimension are in millimeter tolerance is  $\pm 0.1\text{mm}$  unless otherwise noted.  
2.Specifications are subject to change without notice.

## Recommended Soldering Pad Dimensions

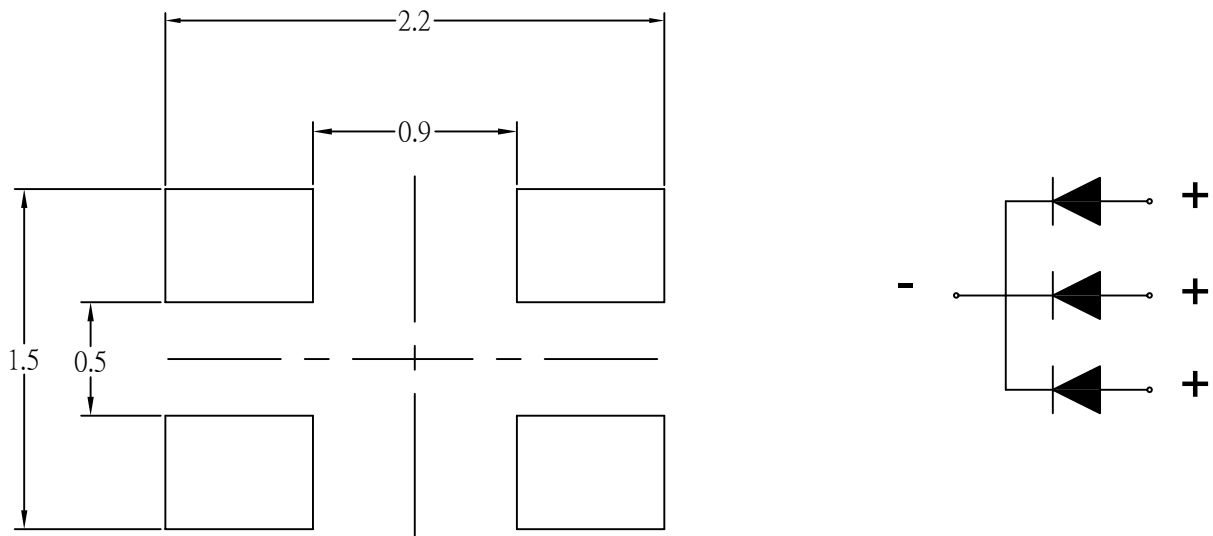

Note : The tolerances unless mentioned is  $\pm 0.1\text{mm}$ , Angle  $\pm 0.5$ . Unit=mm.

**Absolute Maximum Ratings at Ta=25°C**

Parameter	Symbol	Ratings			UNIT
		HRFS (Red)	DGM (Green)	DBK (Blue)	
Power Dissipation	PD	65	72	72	mW
Peak Forward Current Duty 1/10@10KHz	IFP	60	100	100	mA
Forward Current	IF	25	20	20	mA
Reverse Current @5V	Ir	10	50	50	μA
Electrostatic Discharge	ESD	2000	500	500	V
Operating Temperature	Topr	-40 ~ + 85			°C
Storage Temperature	Tstg	-40 ~ + 100			°C

Typical Electrical & Optical Characteristics (Ta=25°C)

Items	Symbol	Min.	Typ.	Max.	UNIT	CONDITION	
Luminous Intensity	Iv	HRFS	125	----	500	mcd	IF=20mA
		DGM	320	----	1250		
		DBK	50	----	200		
Dominant Wavelength	λD	HRFS	615	----	630	nm	IF=20mA
		DGM	515	----	530		
		DBK	460	----	480		
Spectral Line Half-Width	Δλ	HRFS	----	20	----	nm	IF=20mA
		DGM	----	36	----		
		DBK	----	30	----		
Forward Voltage	V <sub>F</sub>	HRFS	1.7	----	2.6	V	IF=20mA
		DGM	2.8	----	3.6		
		DBK	2.8	----	3.6		
Viewing Angle	2θ 1/2	HRFS	----	140	----	deg	IF=20mA
		DGM	----	140	----		
		DBK	----	140	----		

Note : 1.The forward voltage data did not including ±0.1V testing tolerance.  
2. The luminous intensity data did not including ±15% testing tolerance.

### Luminous Intensity Classification

BIN CODE		lv(mcd) at 20mA	
		Min.	Max.
HRFS (Red)	R	125	200
	S	200	320
	T	320	500

BIN CODE		lv(mcd) at 20mA	
		Min.	Max.
DGM (Green)	T	320	500
	U	500	800
	V	800	1250

BIN CODE		lv(mcd) at 20mA	
		Min.	Max.
DBK (Blue)	P	50	80
	Q	80	125
	R	125	200

## Typical Electro-Optical Characteristics Curve

HRFS CHIP

Fig.1 Forward current vs. Forward Voltage

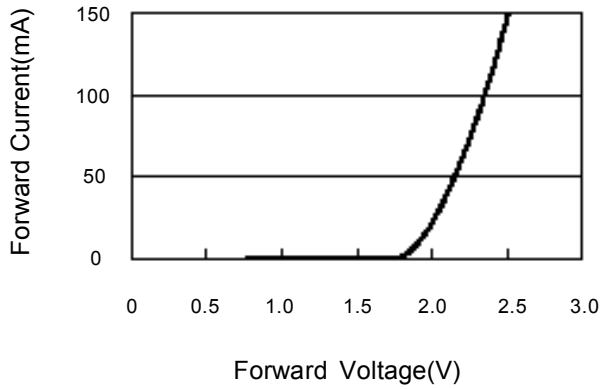

Fig.2 Luminous Intensity vs. Forward Current

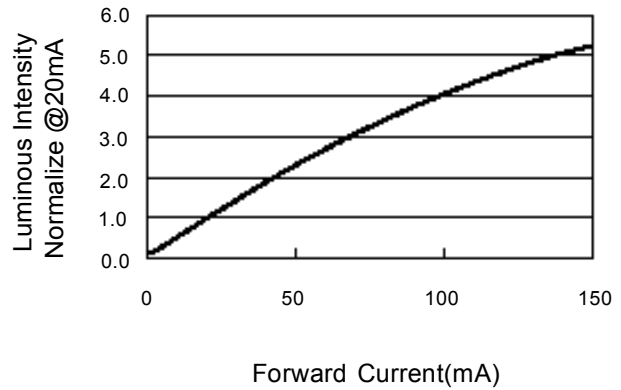

Fig.3 Forward Current vs. Temperature

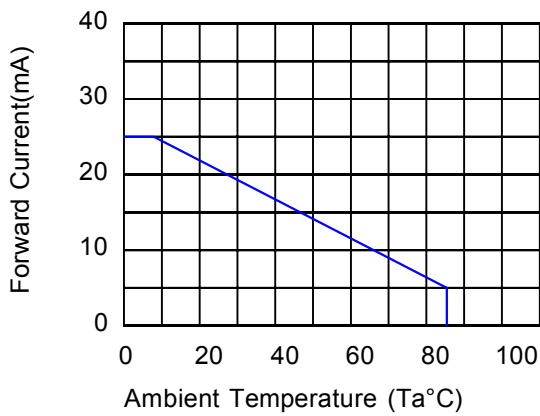

Fig.4 Luminous Intensity vs. Temperature

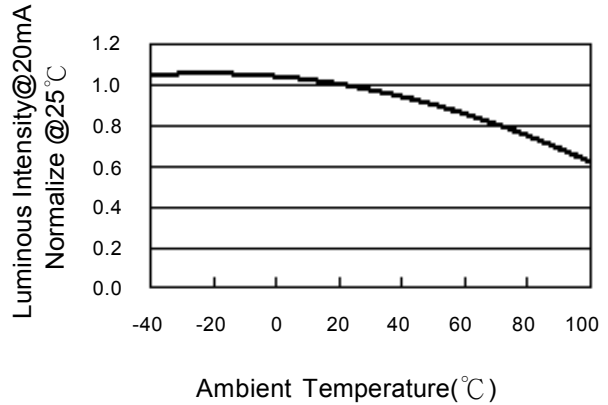

Fig.5 Relative Intensity vs. Wavelength

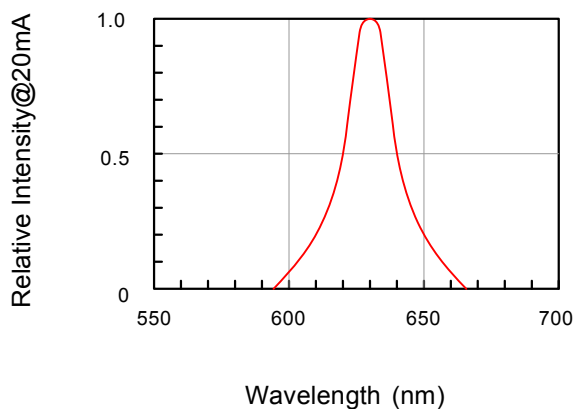
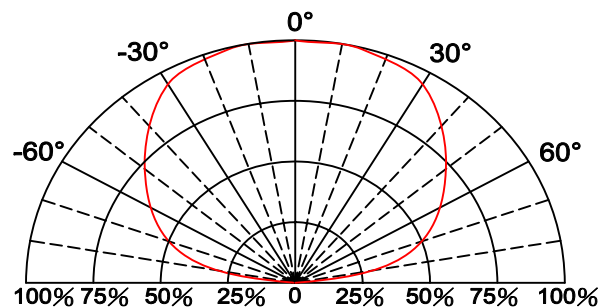

Fig.6 Directive Radiation



## Typical Electro-Optical Characteristics Curve DGM CHIP

Fig.1 Forward current vs. Forward Voltage

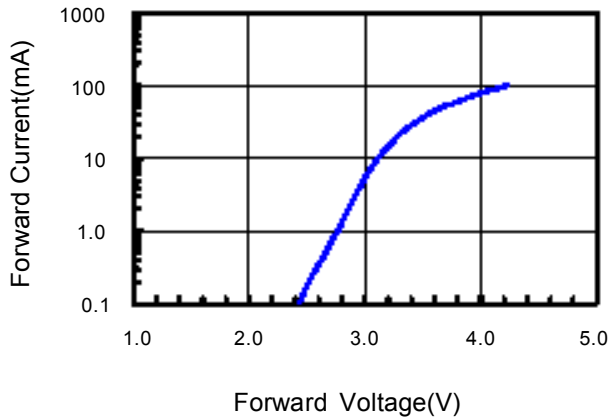

Fig.2 Relative Intensity vs. Forward Current

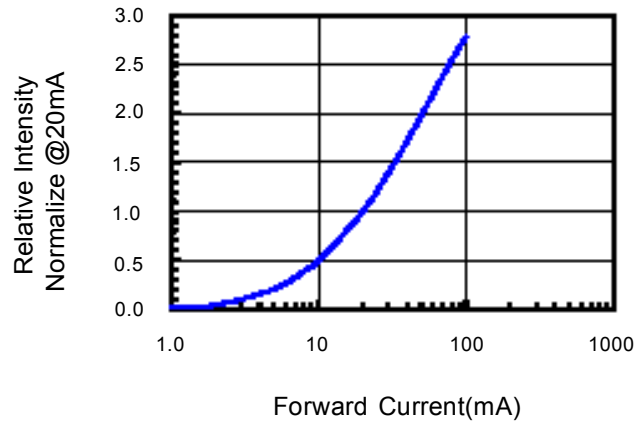

Fig.3 Forward Current vs. Temperature

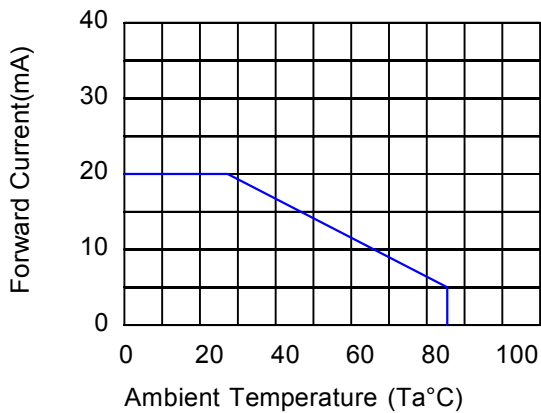

Fig.4 Relative Intensity vs. Temperature

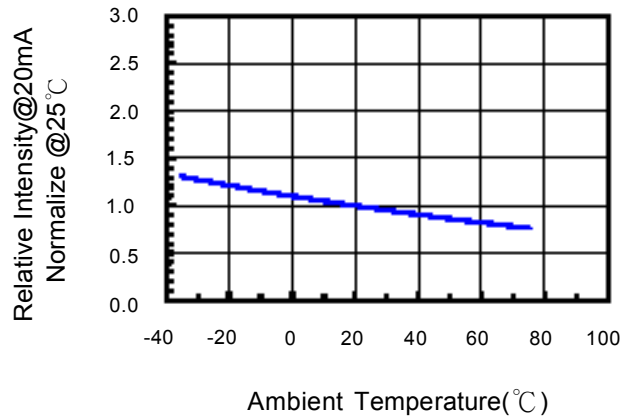

Fig.5 Relative Intensity vs. Wavelength

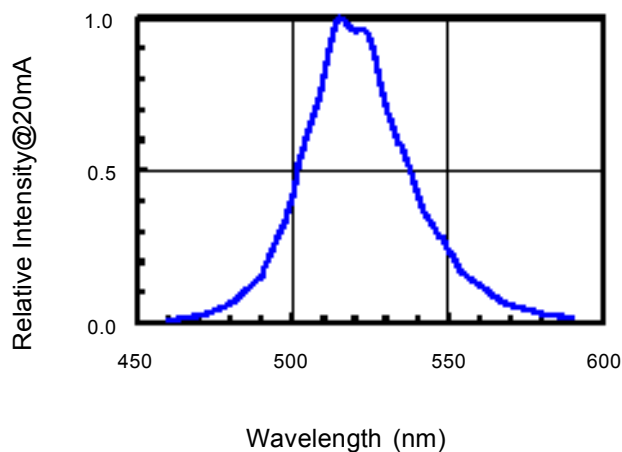
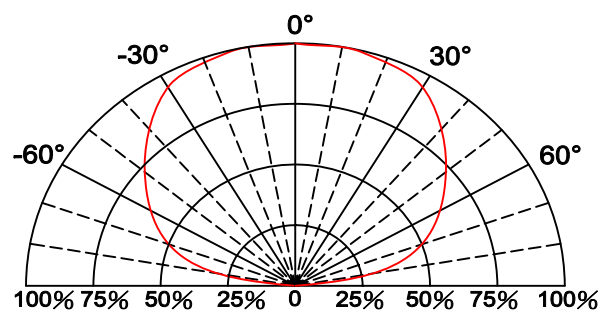

Fig.6 Directive Radiation





## Typical Electro-Optical Characteristics Curve

DBK CHIP

Fig.1 Forward current vs. Forward Voltage

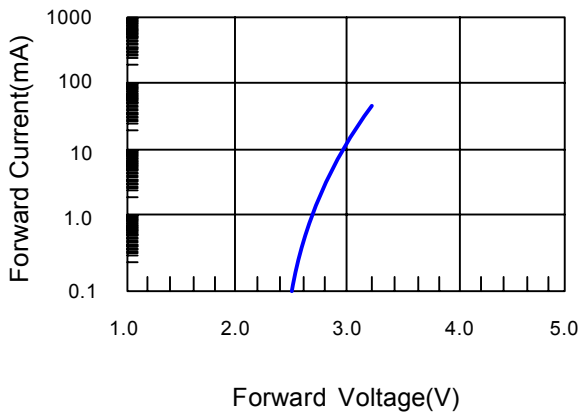

Fig.2 Relative Intensity vs. Forward Current

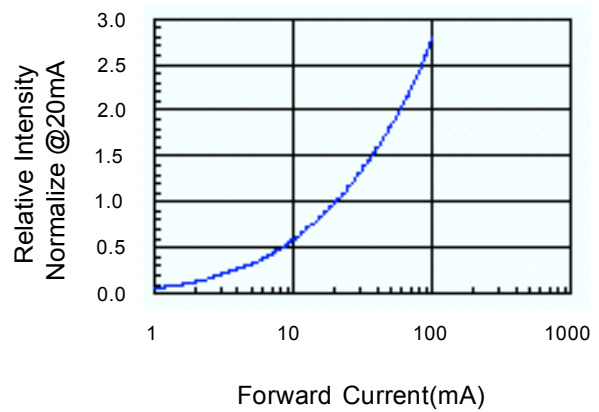

Fig.3 Forward Current vs. Temperature

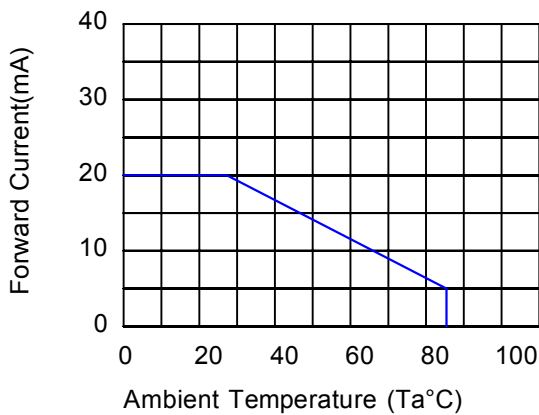

Fig.4 Relative Intensity vs. Temperature

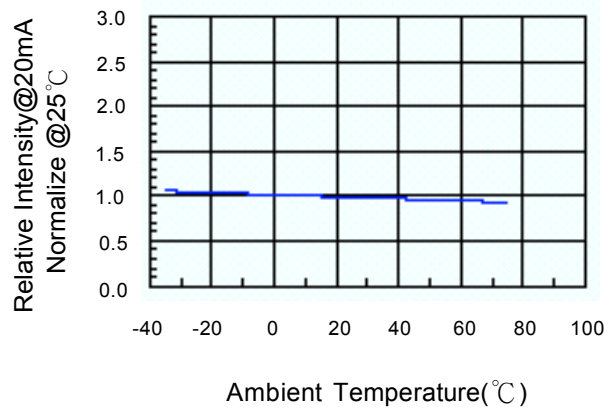

Fig.5 Relative Intensity vs. Wavelength

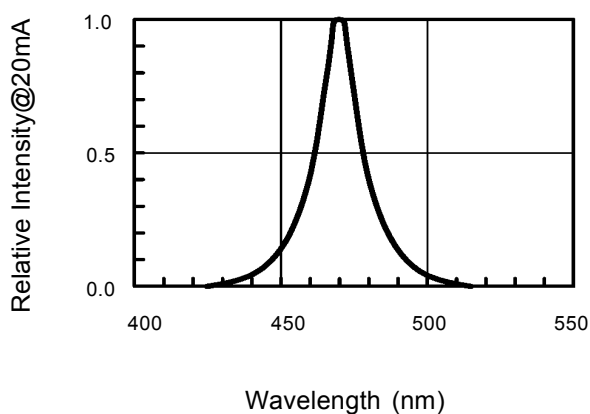
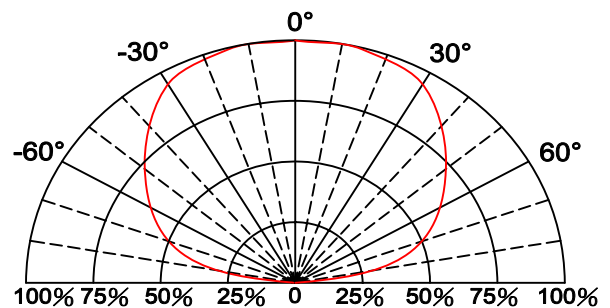
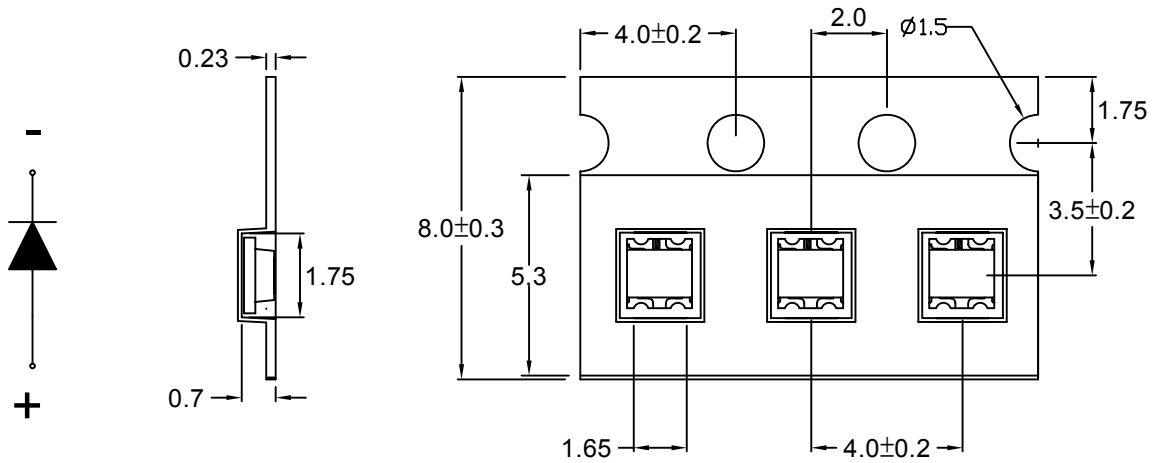

Fig.6 Directive Radiation



### Carrier Tape Dimensions







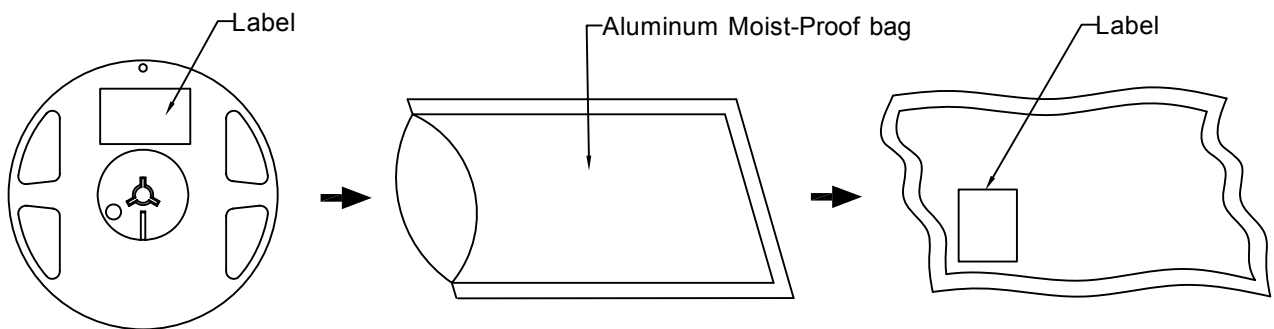

Note : The tolerances unless mentioned is  $\pm 0.1\text{mm}$ , Angle  $\pm 0.5$ . Unit=mm.

### • Packing Specifications



Part No.	Description	Quantity/Reel
LG-197RGB-C-CT-3C1-B01	8.0mm tape,7"reel	4000 devices

## Label Explanation

	LIGITEK ELECTRONICS CO., LTD.	
		
	PART :	LG-197RGB-C-CT-3C1-B01
		
	LOT :	GS11640168
		VF:1.7-2.6
		VF:2.8-3.6
QTY(PCS):	4000	
		VF:2.8-3.6
BIN/HUE :	S-U-Q	
		VF:2.8-3.6

BIN : Luminous Intensity

HUE : Dominant Wavelength

VF : Forward Voltage

## Reel Dimensions

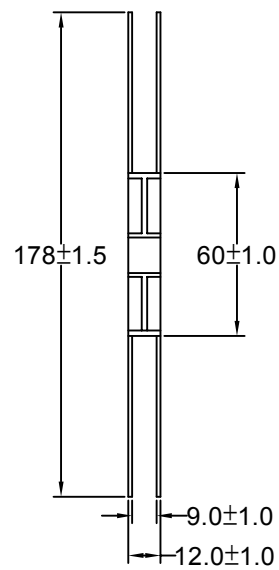
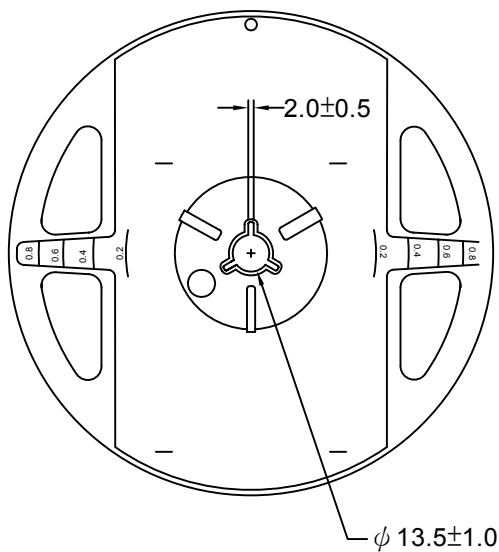

## Box Explanation

1. 5 BAG / INNER BOX
2. INNER BOX SIZE : L X W X H 23cm X 8.5cm x 26cm

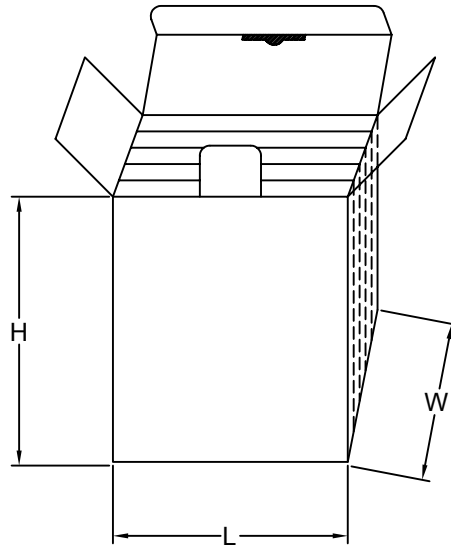

3. 10 INNER BOXES / CARTON
4. CARTON SIZE : L X W X H 58cm X 34cm x 35cm

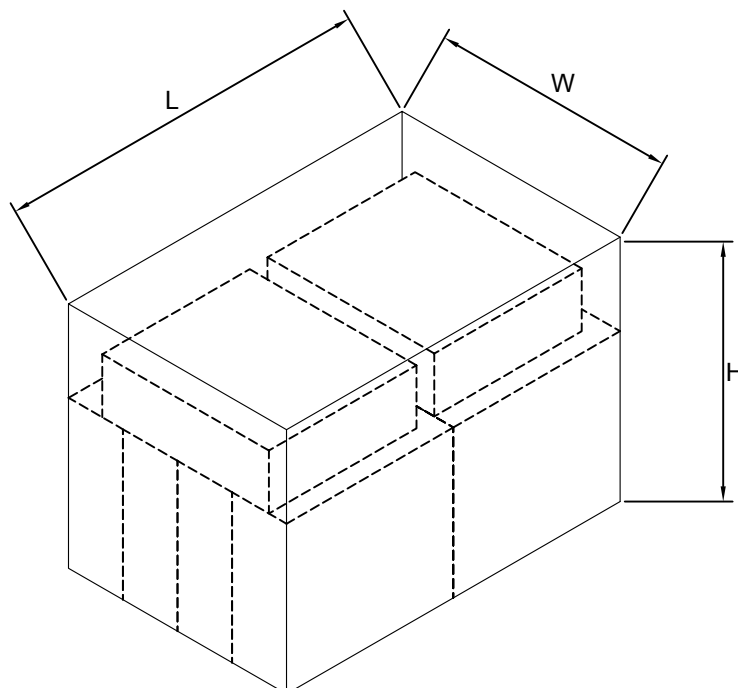

**Recommended Soldering Conditions****1. Hand Solder**

Basic spec is  $\leq 280^{\circ}\text{C}$  3 sec one time only.

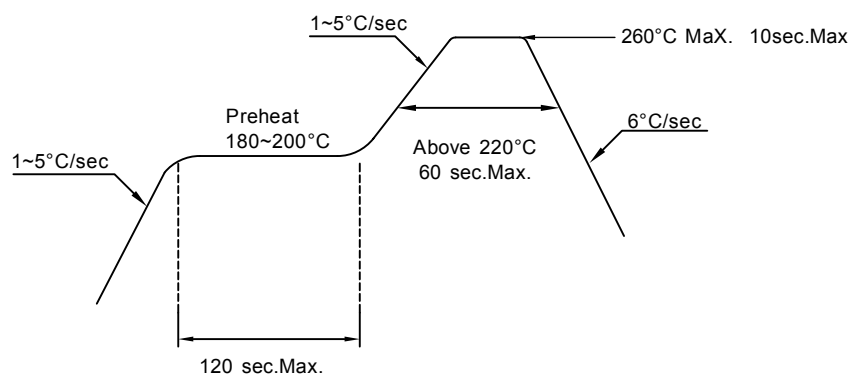
**2. PB-Free Reflow Solder****Note:**

- 1.Reflow soldering should not be done more than two times.
- 2.When soldering,do not put stress on the LEDs during heating.
- 3.After soldering,do not warp the circuit board.

**Precautions For Use:****Storage time:**

1. Calculated shelf life before opening is 18 months at  $< 30^{\circ}\text{C}$  and  $< 90\%$  relative humidity (RH)
2. After bag is opened, devices which will be subjected to reflow soldering or other high temperature processes must be
  - a) Assembled within one years in an environment of  $\leq 30^{\circ}\text{C} / 60\%$  RH, or
  - b) Stored at ambient of 10% RH or less
3. Devices are required baking before assembly if:
  - a) Humidity Indicator Card reads  $>10\%$  (for level 2a -5a) or  $>60\%$  (for level 2) at ambient temperature  $23\pm 5^{\circ}\text{C}$
  - b) 2.a) or 2.b) doesn't meet
4. If baking is required, devices should be baked for  $>72$  hours at  $60\pm 5^{\circ}\text{C} / 5\%$  RH. Performing baking only once, and using the baked devices within 72 hours..

**Drive Method:**

LED is a current operated device, and therefore, requires some kind of current limiting incorporated into the driver circuit. This current limiting typically takes the form of a current limiting resistor placed in series with the LED.

Consider worst case voltage variations than could occur across the current limiting resistor. The forward current should not be allowed to change by more than 40% of its desired value.

Circuit model A

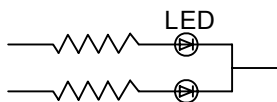

Circuit model B

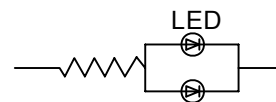

(A) Recommended circuit.

(B) The difference of brightness between LED could be found due to the VF-IF characteristics of LED.

**Cleaning:**

Use alcohol-based cleaning solvents such as isopropyl alcohol to clean the LED.

**ESD(Electrostatic Discharge):**

Static Electricity or power surge will damage the LED. Use of a conductive wrist band or anti-electrostatic glove is recommended when handling these LED. All devices, equipment and machinery must be properly grounded.

Reliability Test:

Classification	Test Item	Test Condition	Sample Size
Endurance Test	Operating Life Test	1.Ta=25°C 2.If=20mA 3.t=1000 hrs (-24hrs,+72hrs)	22
	High Temperature Storage Test	1.Ta=100°C±5°C 2.t=1000 hrs (-24hrs,+72hrs)	22
	Low Temperature Storage Test	1.Ta=-40°C±5°C 2.t=1000 hrs (-24hrs,+72hrs)	22
	High Temperature High Humidity Storage Test	1.Ta=85°C 2.RH=85% 3.t=1000hrs(-24hrs,+72hrs)	22
Environmental Test	Thermal Shock Test	1.Ta=100°C±5°C ~ -40°C±5°C 20min/ 10sec / 20min 2.total 100 cycles	22
	Temperature Cycling	1.100°C±5°C ~ -40°C±5°C 30mins / 5mins / 30mins 2.100 Cyeles	22
	IR Reflow	1.T=260°C Max. 10sec.Max. 2. 6 Min	22