



LIGITEK ELECTRONICS CO.,LTD.
Property of Ligitek Only

SURFACE MOUNT LED TAPE AND REEL



Lead-Free Parts

LWK9553/TR1-CW-A01

DATA SHEET

DOC. NO : QW0905-LWK9553/TR1-CW-A01_B

REV. : B

DATE : 22 - Nov. - 2017



Features:

1. Top view white LED.
2. white SMT package.
3. Leadframe package with individual 2 pin.
4. Wide viewing angle.
5. Soldering methods: IR reflow soldering.
6. Feature of the device: more light due to higher optical efficiency; extremely wide viewing angle; ideal for backlighting and coupling in light guide.

Descriptions:

The LWK9553 SMD has wide viewing angle, low power consumption and white LEDs are devices which are materialized by combining blue LEDs and special phosphors. This feature makes the LED ideal for light guide application.

Applications:

1. LCD back light.
2. Mobile phones.
3. Indicators.
4. Switch lights.

Device Selection Guide:

PART NO	MATERIAL	COLOR	
		Emitted	Lens
LWK9553/TR1-CW-A01	InGaN	White	Yellow Diffused

Package Dimensions

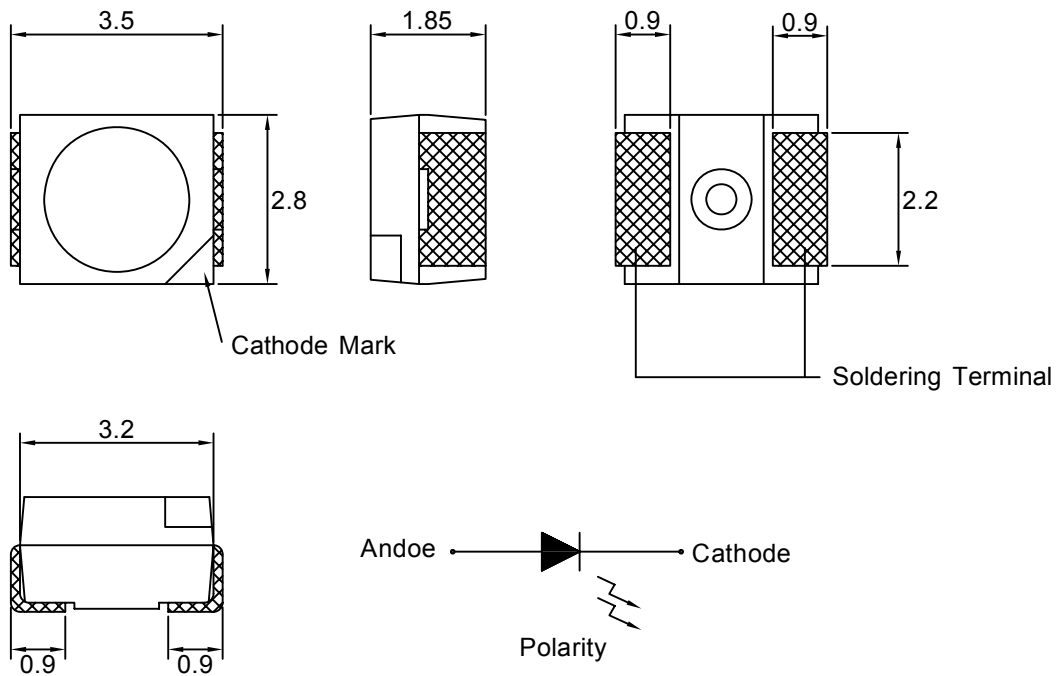

Note : 1.All dimension are in millimeter tolerance is $\pm 0.2\text{mm}$ unless otherwise noted.
2.Specifications are subject to change without notice.

Recommended Soldering Pad Dimensions

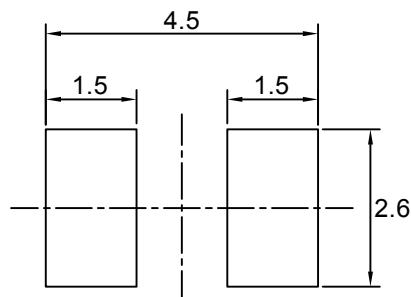

Note : The tolerances unless mentioned is $\pm 0.1\text{mm}$, Unit=mm.

Absolute Maximum Ratings at Ta=25°C

Parameter	Symbol	Ratings	UNIT
Forward Current	IF	30	mA
Peak Forward Current Duty 1/10@10KHz	IFP	100	mA
Power Dissipation	PD	108	mW
Reverse Current @5V	Ir	50	μA
Electrostatic Discharge	ESD	500	V
Operating Temperature	Topr	- 40 ~ + 85	°C
Storage Temperature	Tstg	- 40 ~ + 100	°C

Typical Electrical & Optical Characteristics (Ta=25°C)

Items	Symbol	Min.	Typ.	Max.	UNIT	CONDITION
Luminous Intensity	Iv	2100	2200	----	mcd	IF=20mA
Chromaticity Coordinates	X	0.3032	----	0.329	----	IF=20mA
	Y	0.3106	----	0.357	----	IF=20mA
Forward Voltage	V _F	2.8	----	3.6	V	IF=20mA
Viewing Angle	2θ 1/2	----	120	----	deg	IF=20mA

Note : 1.The forward voltage data did not including ±0.1V testing tolerance.
 2.The luminous intensity data did not including ±15% testing tolerance.
 3.The color coordinates measurement allowance is ±0.01 testing tolerance.

Luminous Intensity Classification

BIN CODE	Iv(mcd) at 20mA	
	Min.	Max.
X13X14	2100	2200
X15X16	2200	2300
X17X18	2300	2400
X19X20	2400	2500
X21X22	2500	2600

Forward Voltage Classification

BIN CODE	Vf(v) at20mA	
	Min.	Max.
1	2.8	2.9
2	2.9	3.0
3	3.0	3.1
4	3.1	3.2
5	3.2	3.3
6	3.3	3.4
7	3.4	3.5
8	3.5	3.6

Chromaticity Coordinates Specifications For Bin Grading

Color Coordiante at 20mA									
CCT(K)	BIN CODE	1		2		3		4	
		X	Y	X	Y	X	Y	X	Y
5650~6300	WN	0.315	0.344	0.329	0.357	0.329	0.345	0.316	0.333
	WO	0.316	0.333	0.329	0.345	0.329	0.331	0.317	0.32
6300~7000	XN	0.3032	0.3332	0.315	0.344	0.316	0.333	0.3053	0.3222
	XO	0.3053	0.3222	0.316	0.333	0.317	0.32	0.3076	0.3106

CIE Chromaticity Diagram

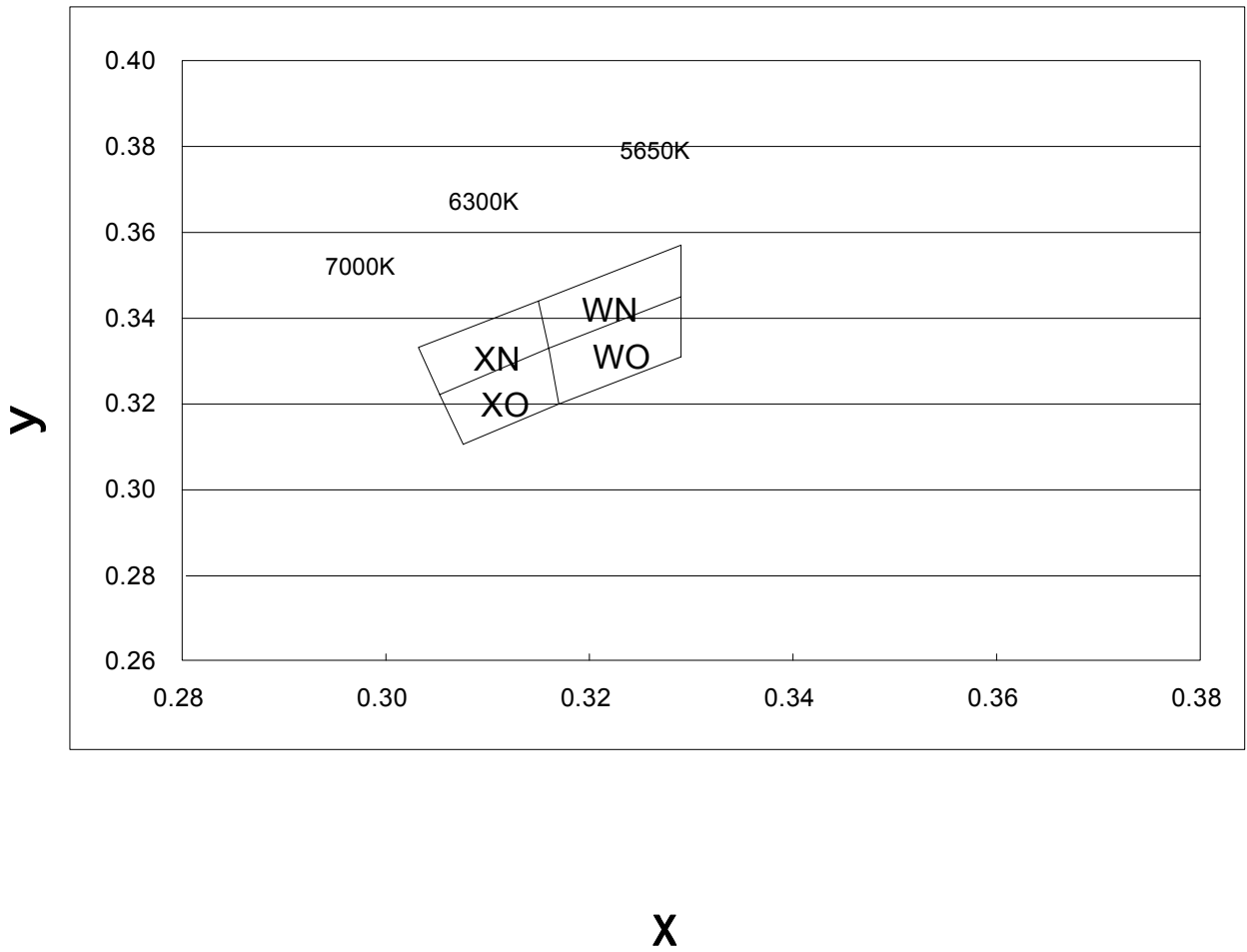

Typical Electro-Optical Characteristics Curve

WK CHIP

Fig.1 Forward current vs. Forward Voltage

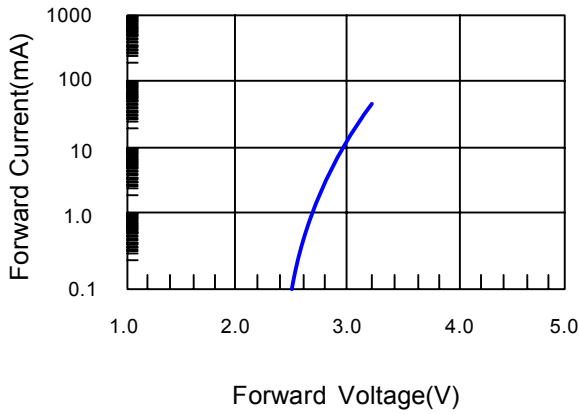

Fig.2 Relative Intensity vs. Forward Current

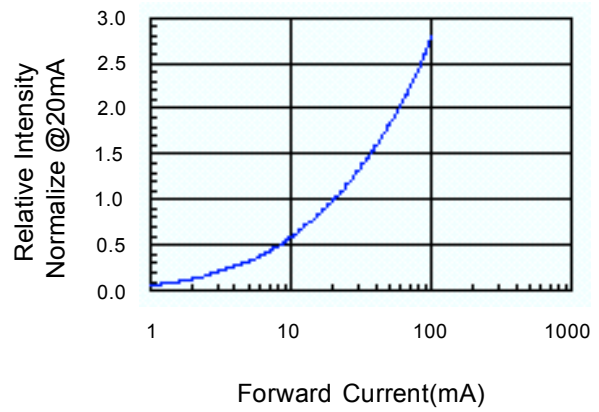

Fig.3 Forward Voltage vs. Temperature

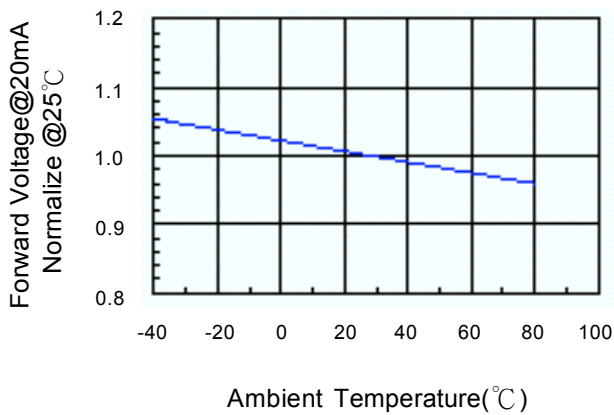

Fig.4 Relative Intensity vs. Temperature

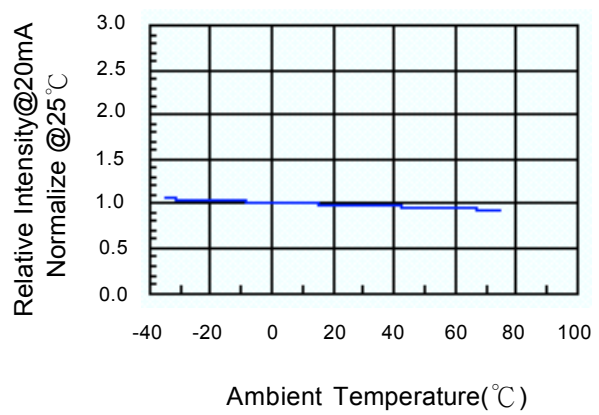

Fig.5 Luminous Spectrum (Ta=25°C)

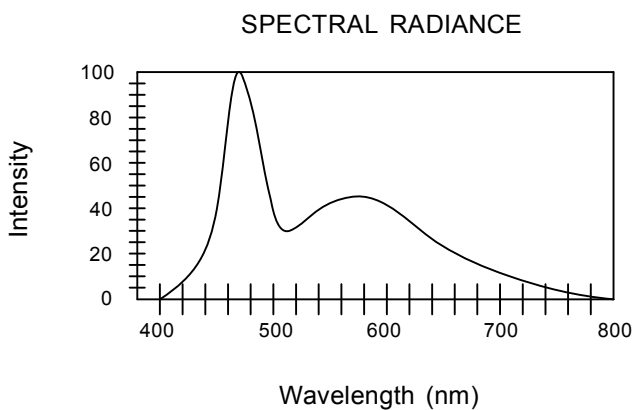
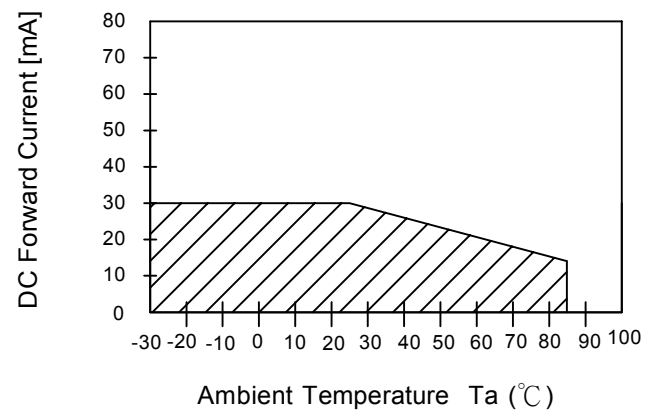
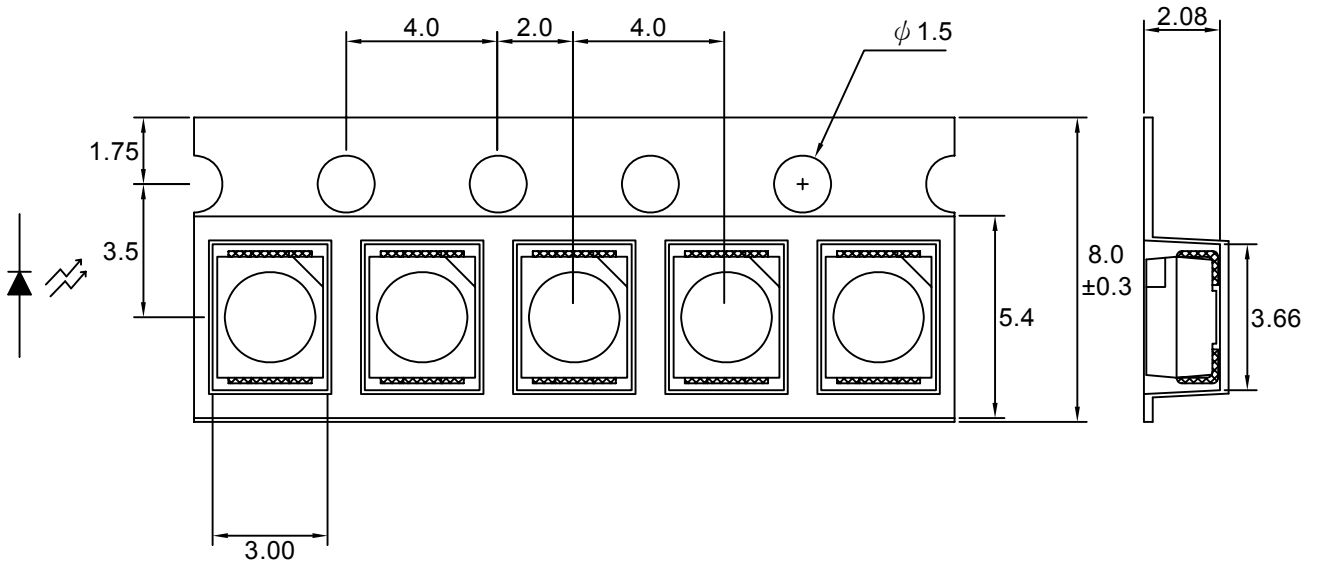

Fig.6 Forward Current vs. Temperature



Carrier Type Dimensions







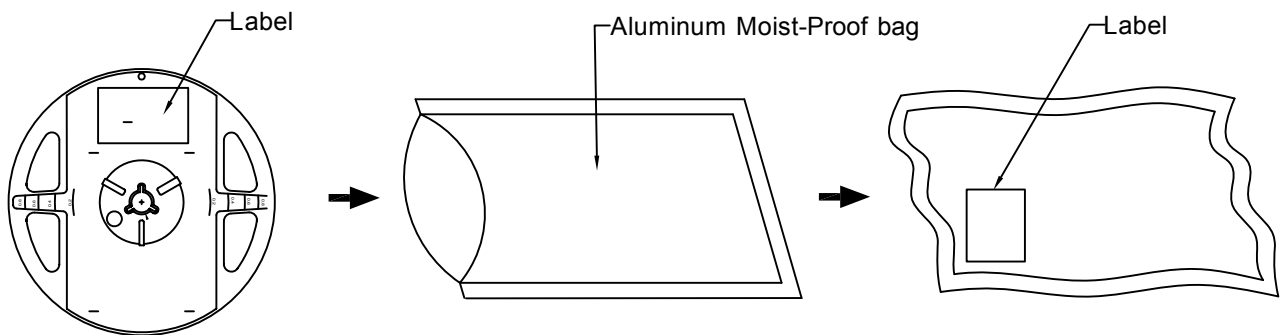

Note : The tolerances unless mentioned is ± 0.1 mm, Angle ± 0.5 . Unit=mm.

• Packing Specifications



Part No.	Description	Quantity/Reel
LWK9553/TR1-CW-A01	8.0mm tape,7"reel	2000 PCS

Label Explanation

	LIGITEK ELECTRONICS CO., LTD.	
		
	PART :	LWK9553/TR1/A-CW-A01
		
	LOT :	GS15020168
		
QTY(PCS):	2000	
		
BIN/HUE :	X19X20/XN	VF:3.2-3.3

BIN : Luminous Intensity

HUE : Chromaticity Coordinates
(CIE_x , CIE_y)

3.2 - 3.3 : Forward Voltage

Reel Dimensions

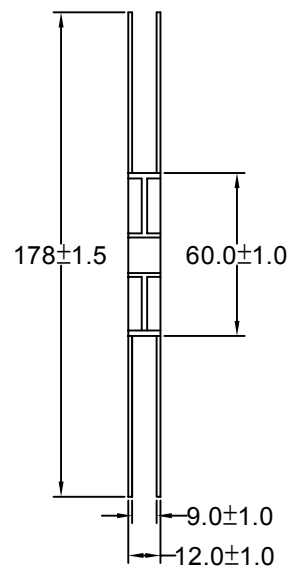
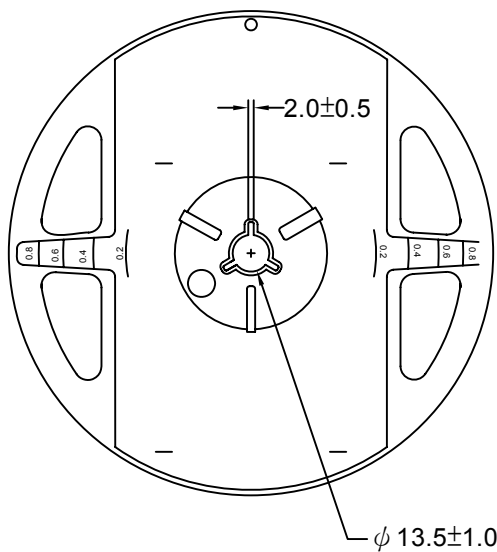

Box Explanation

1. 5 BAG / INNER BOX

2. INNER BOX SIZE : L X W X H 23cm X 8.5cm x 26cm

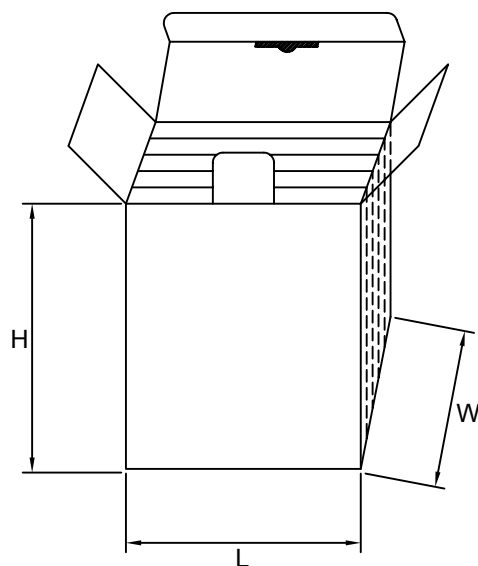

3. 10 INNER BOXES / CARTON

4. CARTON SIZE : L X W X H 58cm X 34cm x 35cm

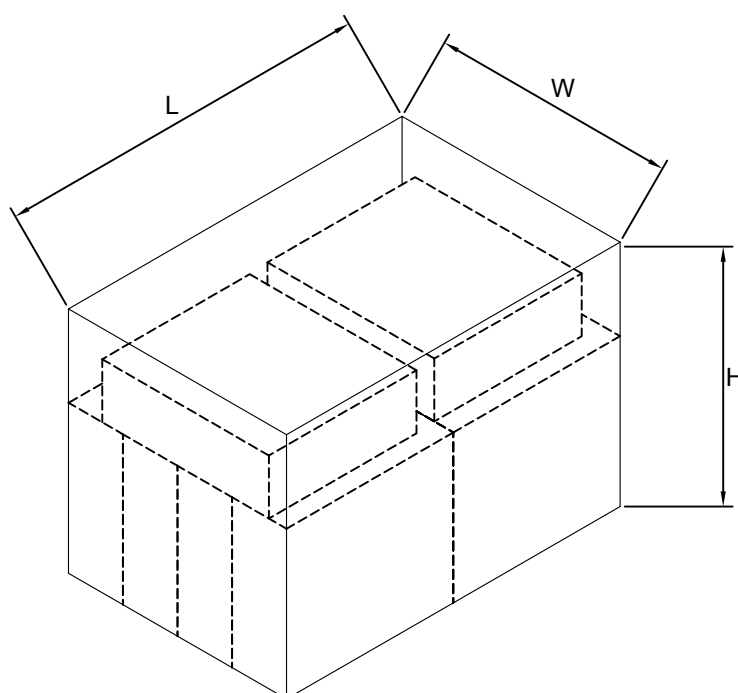

Recommended Soldering Conditions**1. Hand Solder**

Basic spec is $\leq 320^{\circ}\text{C}$ 3 sec one time only.

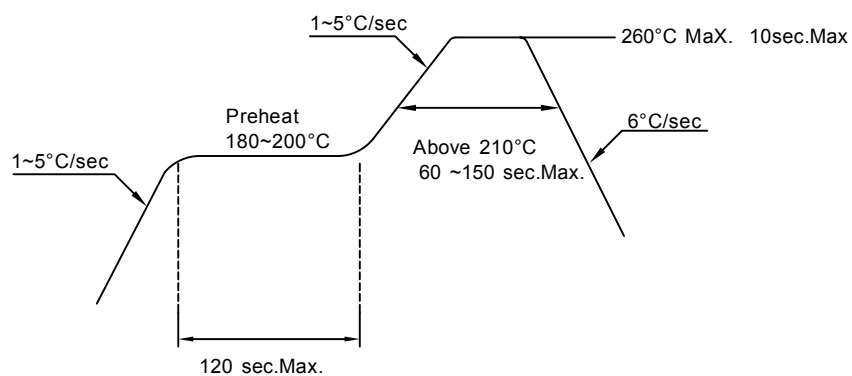
2. PB-Free Reflow Solder**Note:**

- 1.Reflow soldering should not be done more than two times.
- 2.When soldering,do not put stress on the LEDs during heating.
- 3.After soldering,do not warp the circuit board.

Precautions For Use:**Storage time:**

1. Calculated shelf life before opening is 12 months at $< 30^{\circ}\text{C}$ and $< 90\%$ relative humidity (RH)
2. After bag is opened, devices which will be subjected to reflow soldering or other high temperature processes must be
 - a) Assembled within 168 hours in an environment of $\leq 30^{\circ}\text{C} / 60\%$ RH, or
 - b) Stored at ambient of 10% RH or less
3. Devices are required baking before assembly if:
 - a) Humidity Indicator Card reads $>10\%$ (for level 2a -5a) or $>60\%$ (for level 2) at ambient temperature $23 \pm 5^{\circ}\text{C}$
 - b) 2.a) or 2.b) doesn't meet
4. If baking is required, devices should be baked for >72 hours at $60 \pm 5^{\circ}\text{C} / 5\%$ RH. Performing baking only once, and using the baked devices within 72 hours.

Drive Method:

LED is a current operated device, and therefore, requires some kind of current limiting incorporated into the driver circuit. This current limiting typically takes the form of a current limiting resistor placed in series with the LED.

Consider worst case voltage variations than could occur across the current limiting resistor. The forward current should not be allowed to change by more than 40% of its desired value.

Circuit model A

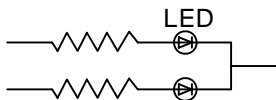

Circuit model B

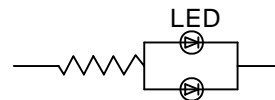

(A) Recommended circuit.

(B) The difference of brightness between LED could be found due to the VF-IF characteristics of LED.

Cleaning:

Use alcohol-based cleaning solvents such as isopropyl alcohol to clean the LED.

ESD(Electrostatic Discharge):

Static Electricity or power surge will damage the LED. Use of a conductive wrist band or anti-electrostatic glove is recommended when handling these LED. All devices, equipment and machinery must be properly grounded.

Reliability Test:

Classification	Test Item	Test Condition	Sample Size
Endurance Test	Operating Life Test	1.Ta=25°C 2.If=20mA 3.t=1000 hrs (-24hrs,+72hrs)	22
	High Temperature Storage Test	1.Ta=100°C±5°C 2.t=1000 hrs (-24hrs,+72hrs)	22
	Low Temperature Storage Test	1.Ta=-40°C±5°C 2.t=1000 hrs (-24hrs,+72hrs)	22
	High Temperature High Humidity Storage Test	1.Ta=85°C 2.RH=85% 3.t=1000hrs(-24hrs,+72hrs)	22
Environmental Test	Thermal Shock Test	1.Ta=100°C±5°C ~ -40°C±5°C 20min/ 10sec / 20min 2.total 100 cycles	22
	Temperature Cycling	1.100°C±5°C ~ -40°C±5°C 30mins / 5mins / 30mins 2.100 Cyeles	22
	IR Reflow	1.T=260°C Max. 10sec.Max. 2. 6 Min	22